

FLORENZ BAD 31

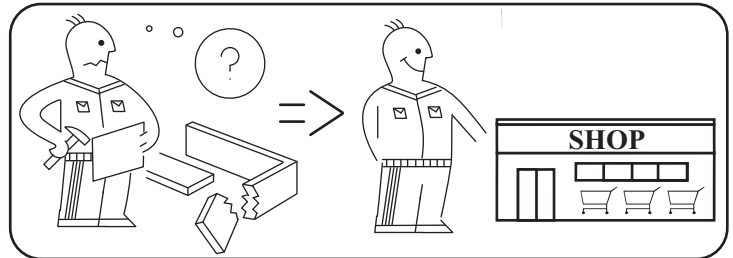

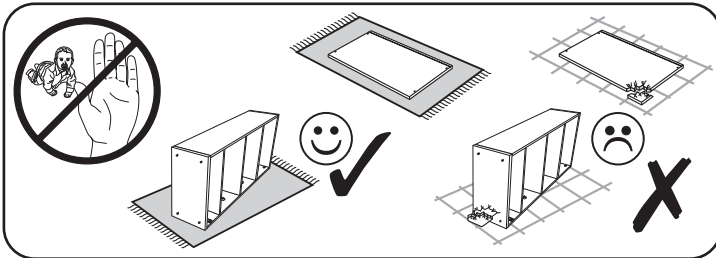

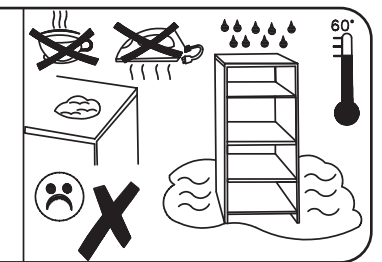
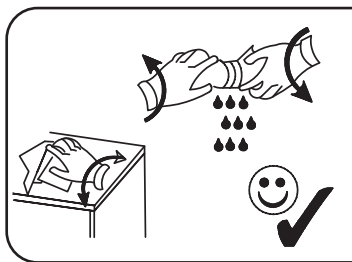
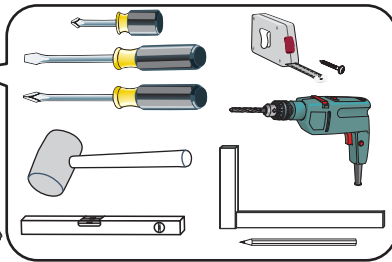
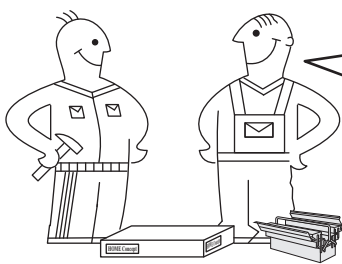
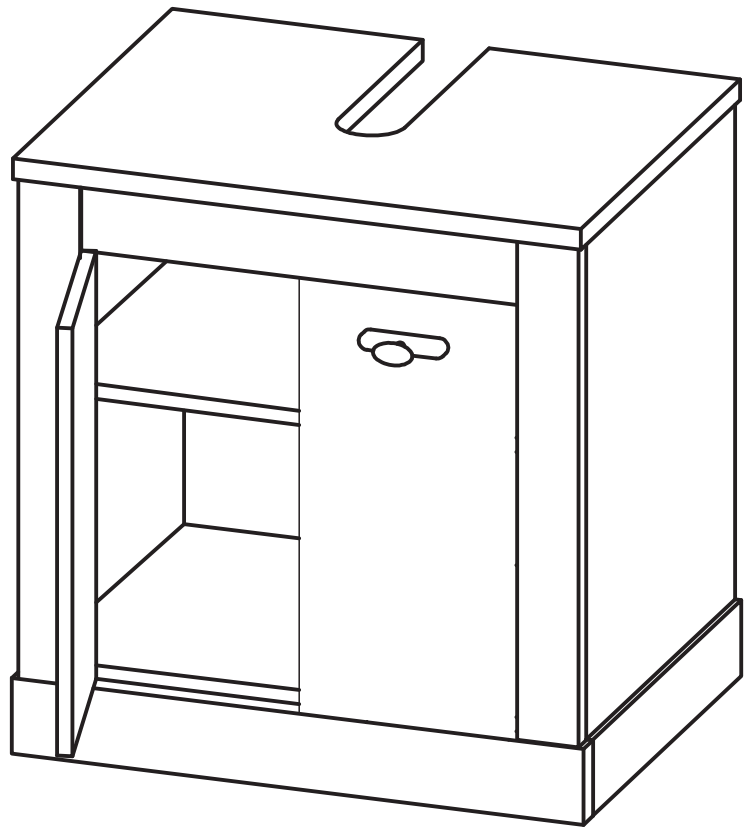
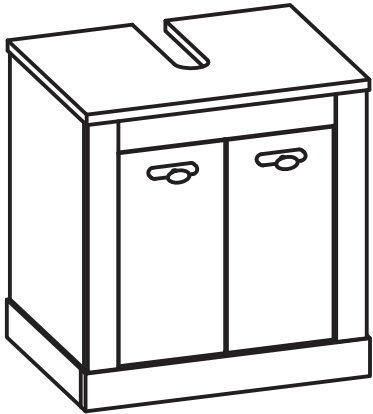
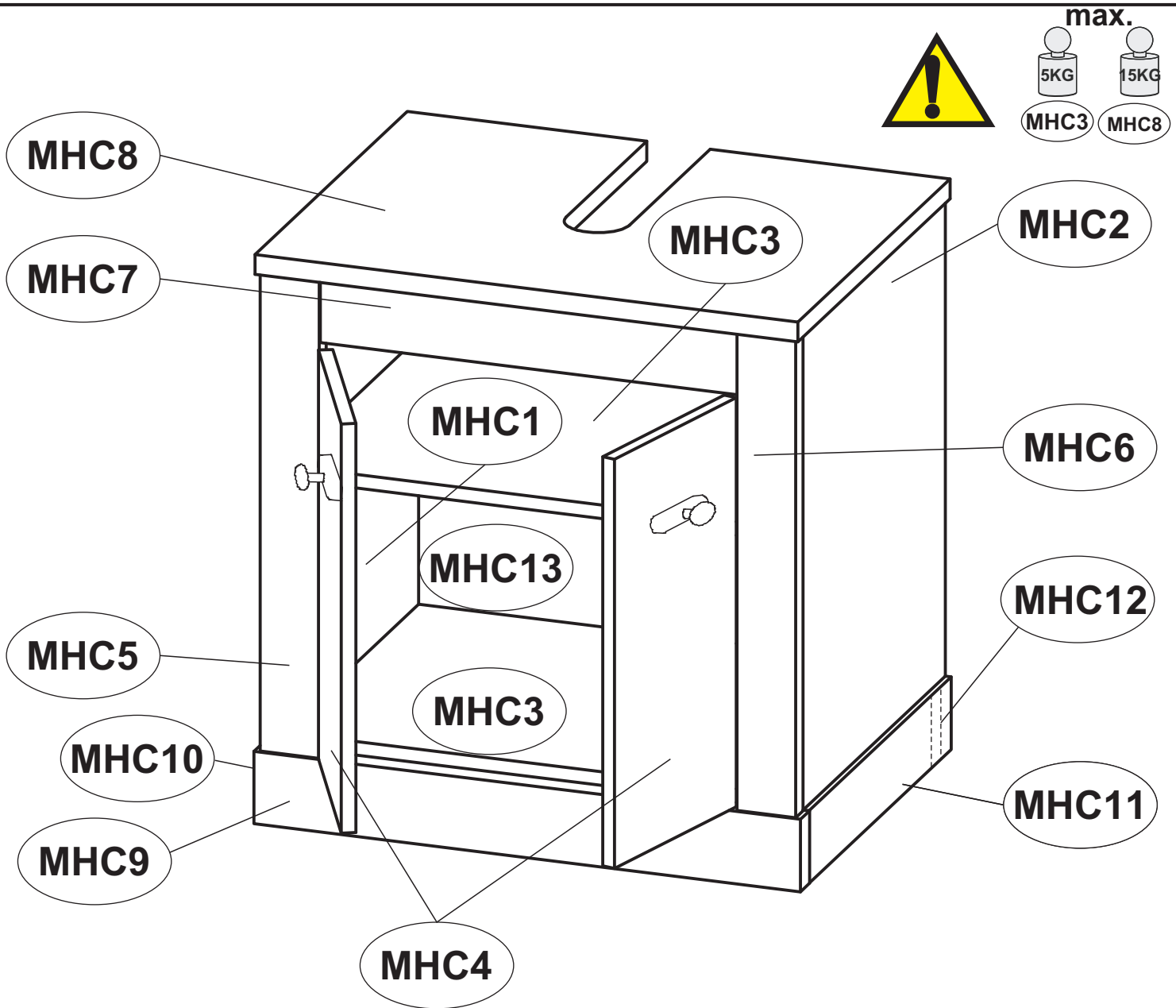

FLORENZ BAD 31



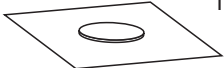
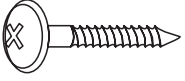
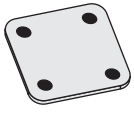
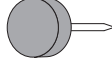
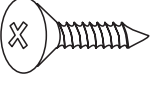
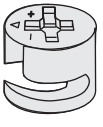
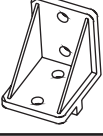
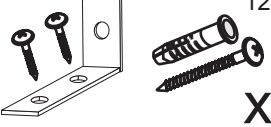
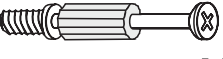
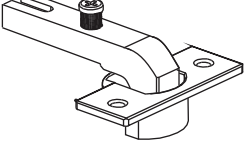
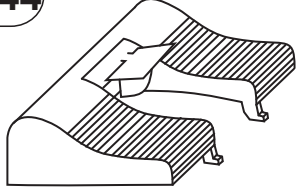

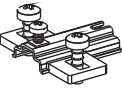
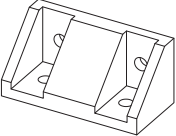
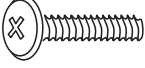
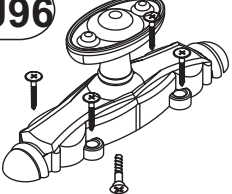
MHC1	528	435	15	1/1
MHC2	528	435	15	1/1
MHC3	560	414	15	1/1
MHC4	452	226	15	1/1
MHC5	528	65	22	1/1
MHC6	528	65	22	1/1
MHC7	462	70	18	1/1
MHC8	600	462	22	1/1
MHC9	604	80	28	1/1
MHC10	428	80	28	1/1
MHC11	428	80	32	1/1
MHC12	539	70	15	1/1
MHC13	325	572	3	1/1

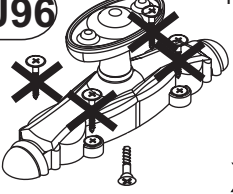
FLORENZ BAD 31



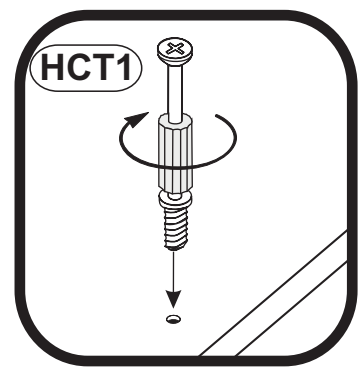
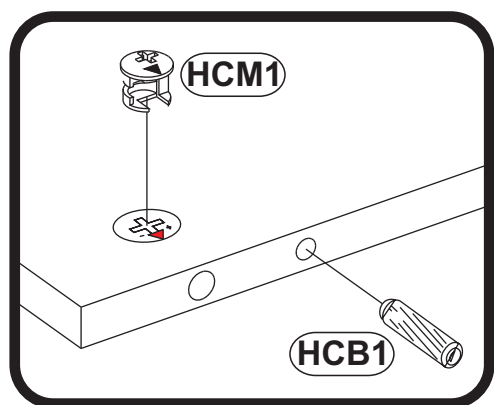
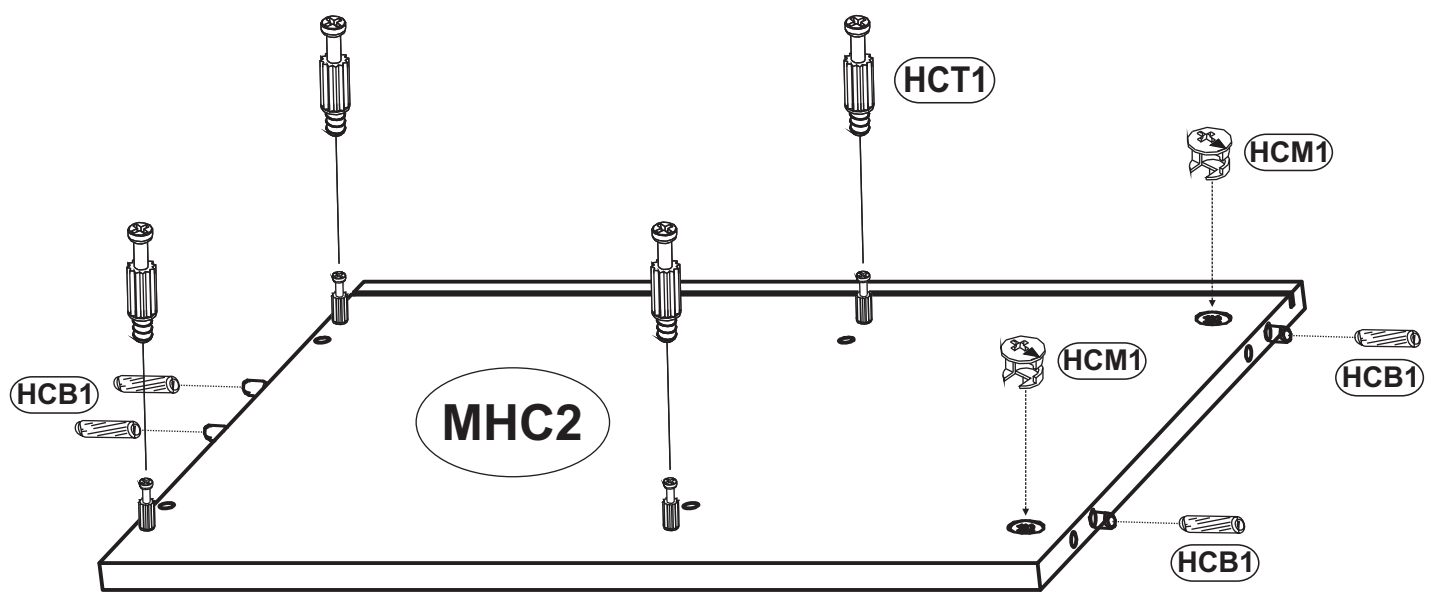
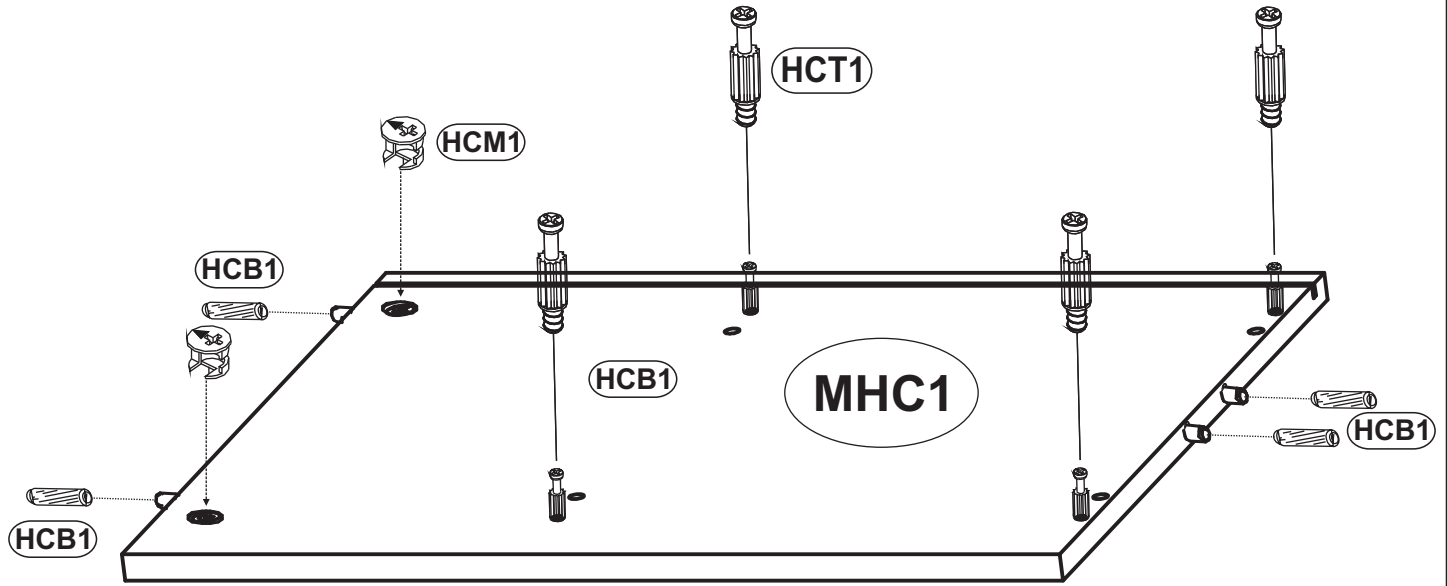

HCB1  1018 8x28 x16	HCC6  140318 φ20 x8	HCP6  1056 3x20 x8
HCF14  1021 x2	HCF36  1305 x6	HCS3  1011 3,5x13 x72
HCM1  123894 x20	HCK13  49716 x8	HCJ11  1267 x2
HCT1  11809 x20	HCZ4  49365 φ35 90° x4	HCF44  116795 x2
HCJ23  1302 x4	HCD14  23515 H4 x4	HCK152  84556 x6
HCA6  2549 WPM 4x22 x4	HCU96  126321 x2	HCG69  147119 x1
HCU96  126321 x2		

1

HCB1		1018
	8x28	x8
HCM1		123894
		x4
HCT1		11809
		x8



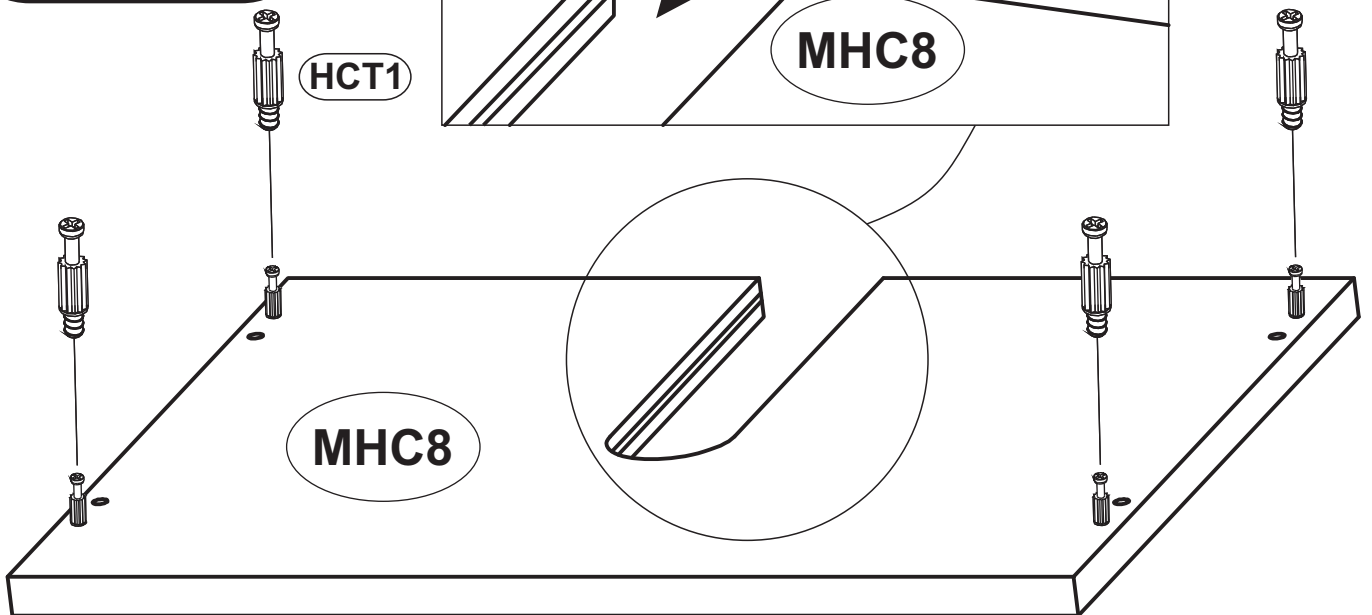
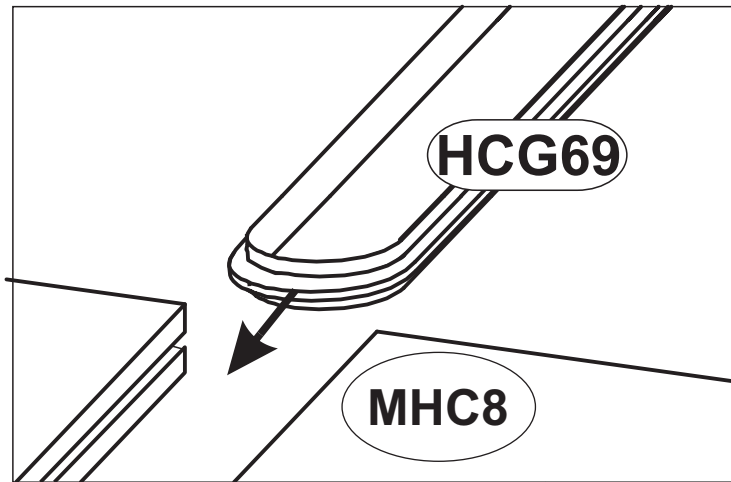
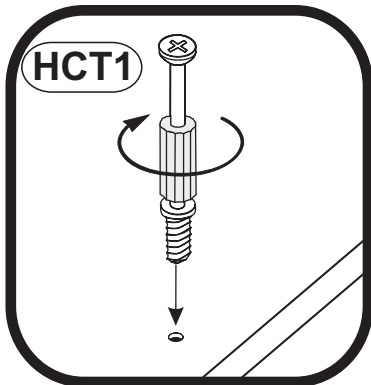
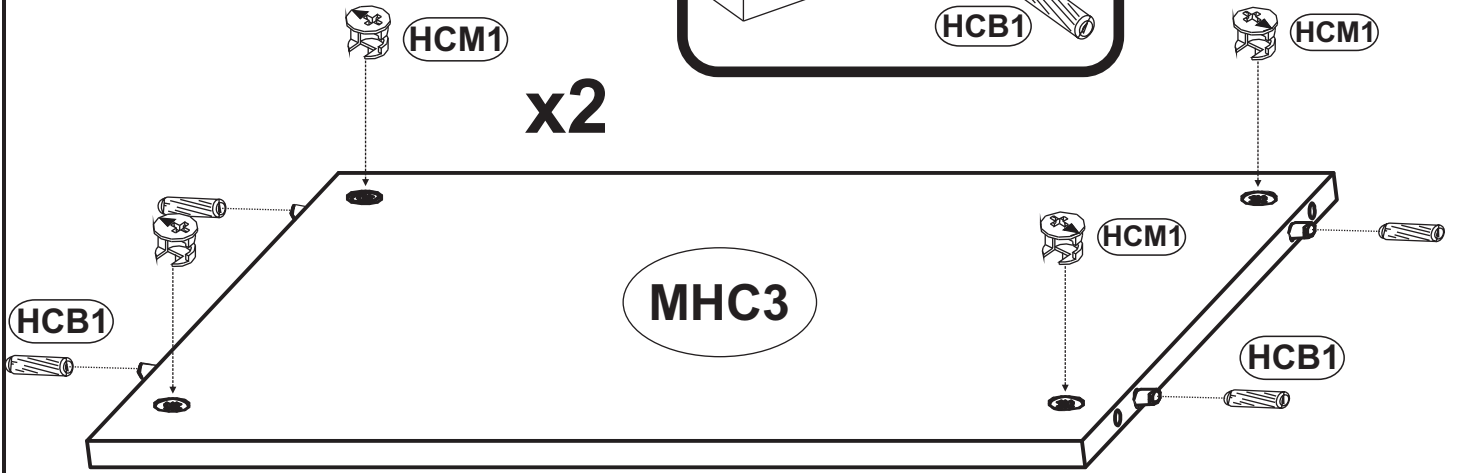
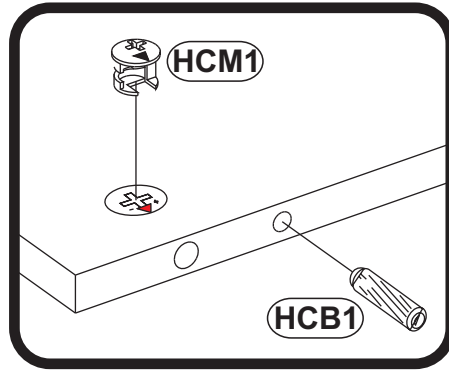

2

HCB1		1018
	8x28	x8
HCM1		123894
		x8
HCT1		11809
		x4
HCG69		147119
		x1



3

HCS3		1011
	3,5x13	x12

HCM1		123894
		x8

HCK152		84556
		x6

HCT1		11809
		x8

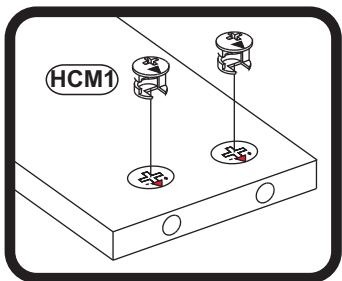
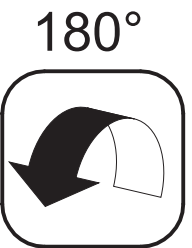
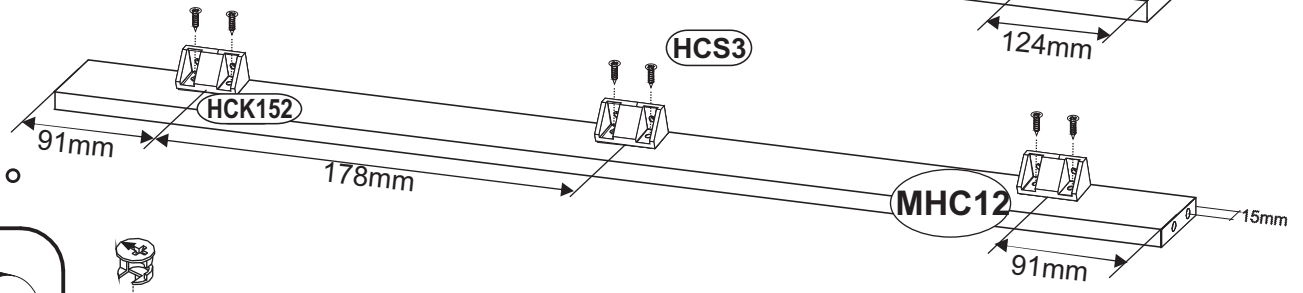
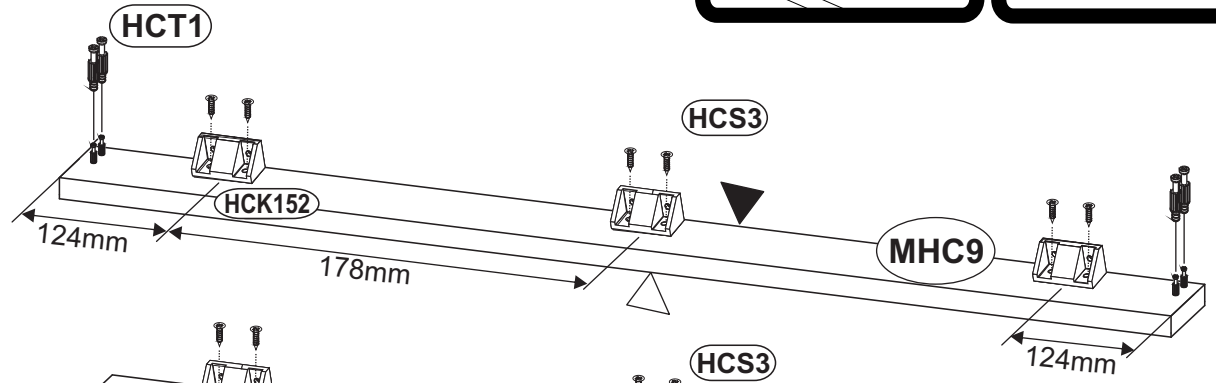
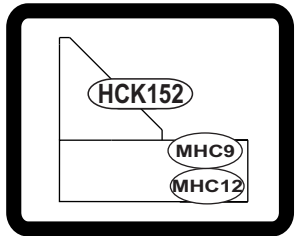
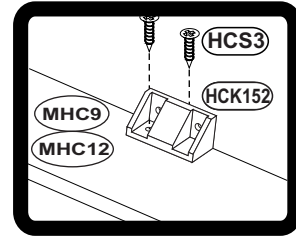
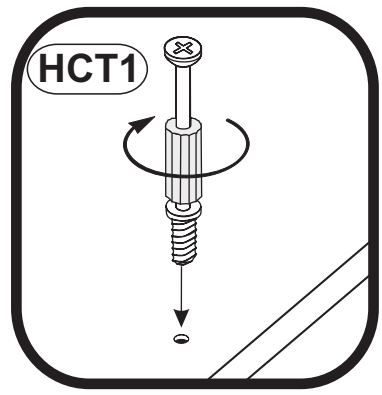
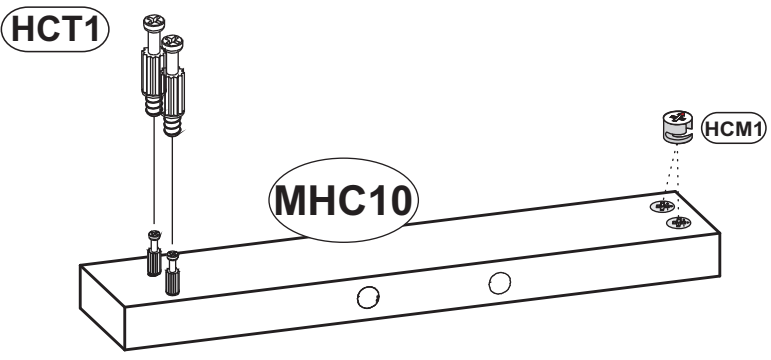
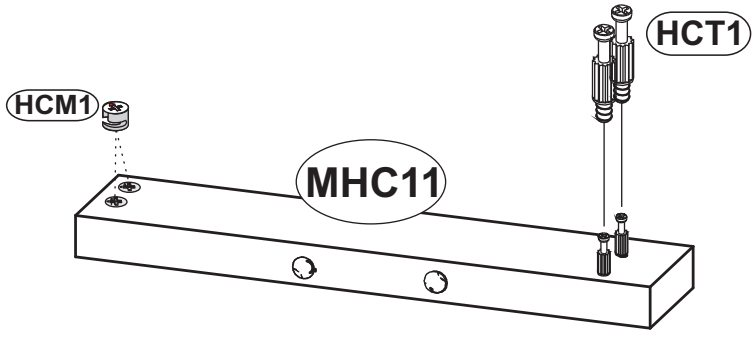

4

HCF36 1305
x6

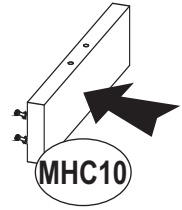
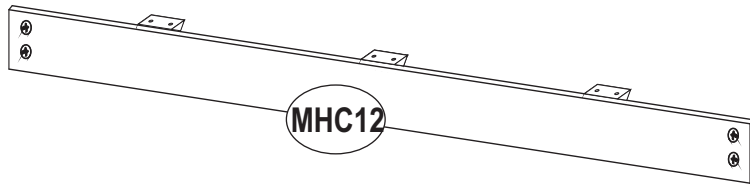
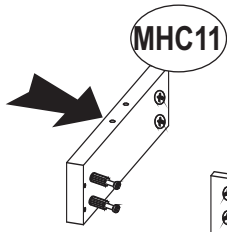
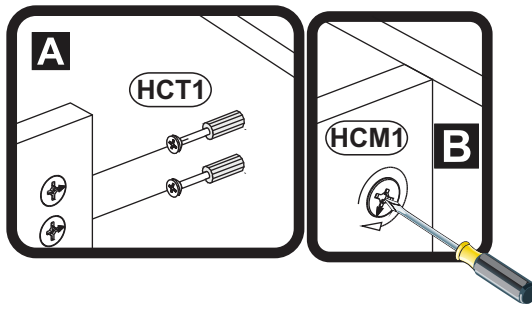

180°

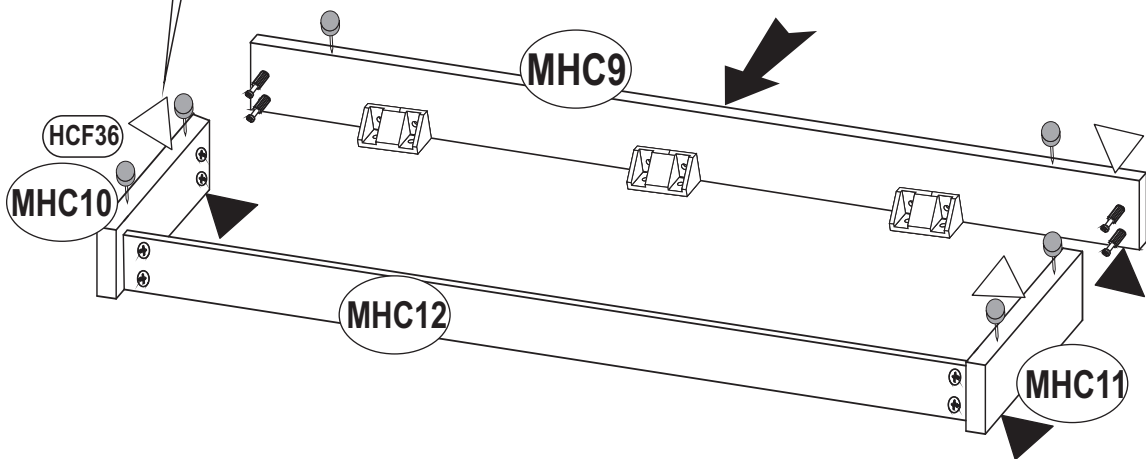
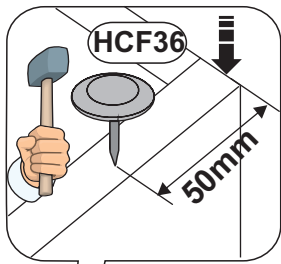
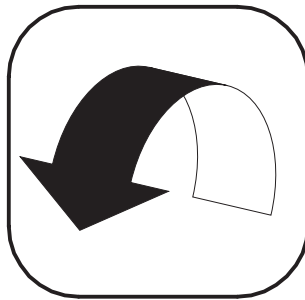

5

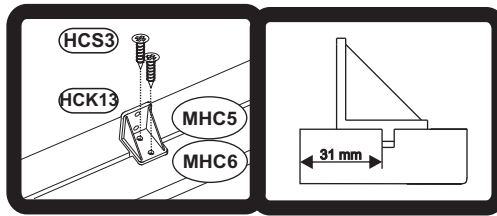
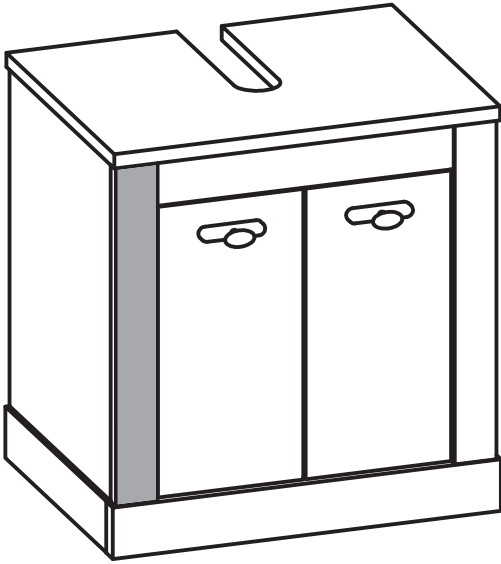

HCK13		49716	x8
HCS3		1011	x16
HCD14		23515	x4

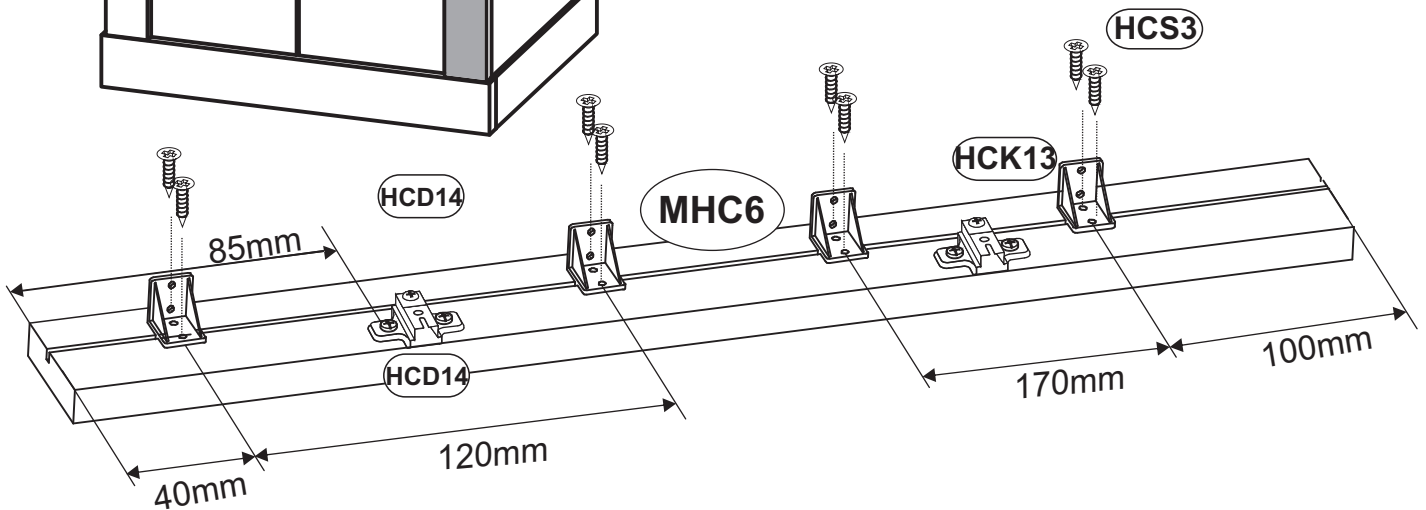
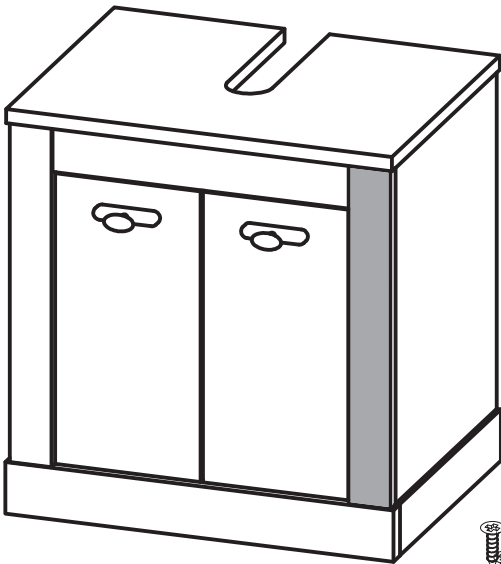
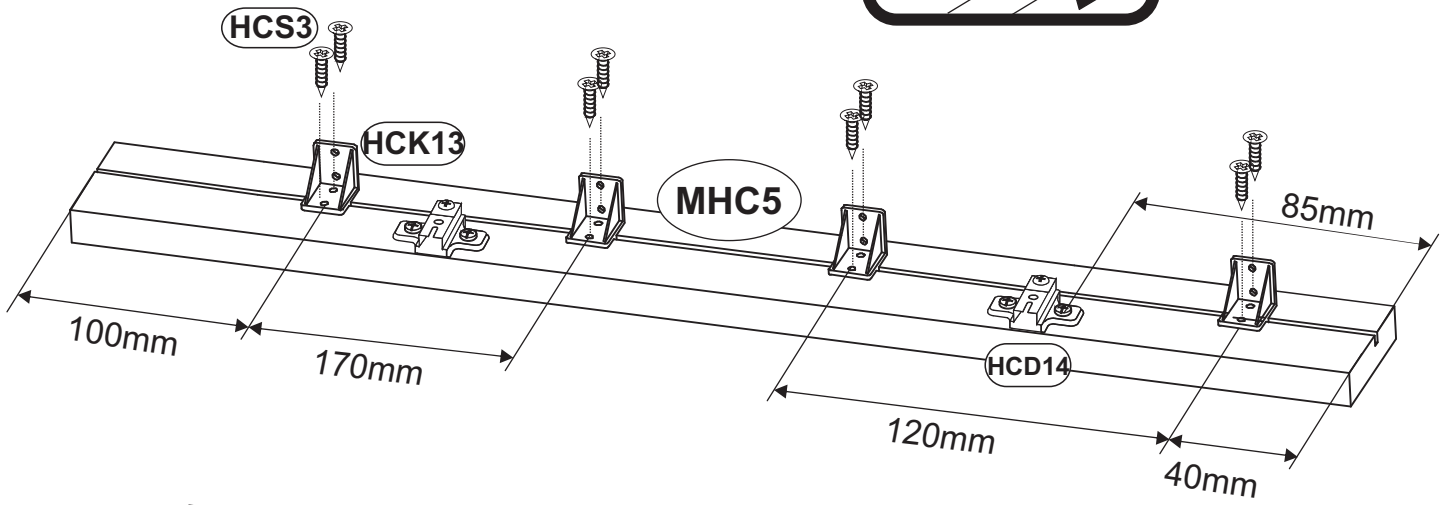
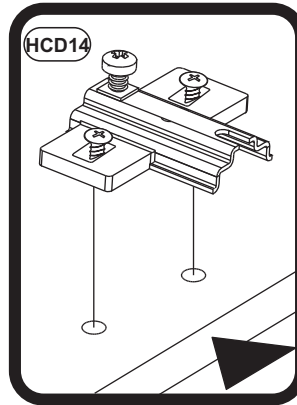

6

HCF14		1021
		x2
HCS3		1011
	3,5x13	x12
HCF44		116795
		x2
HCZ4		49365
	∅35 90°	x4

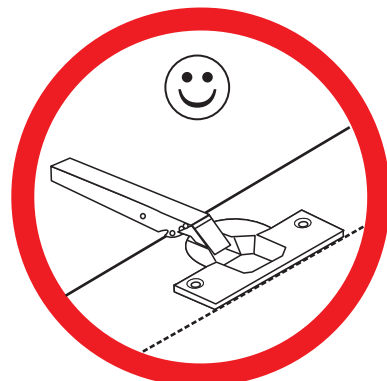
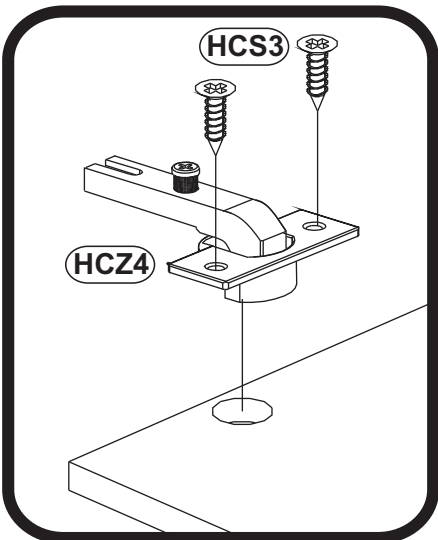
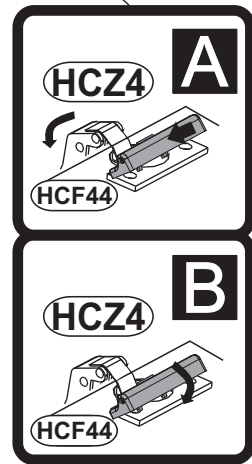
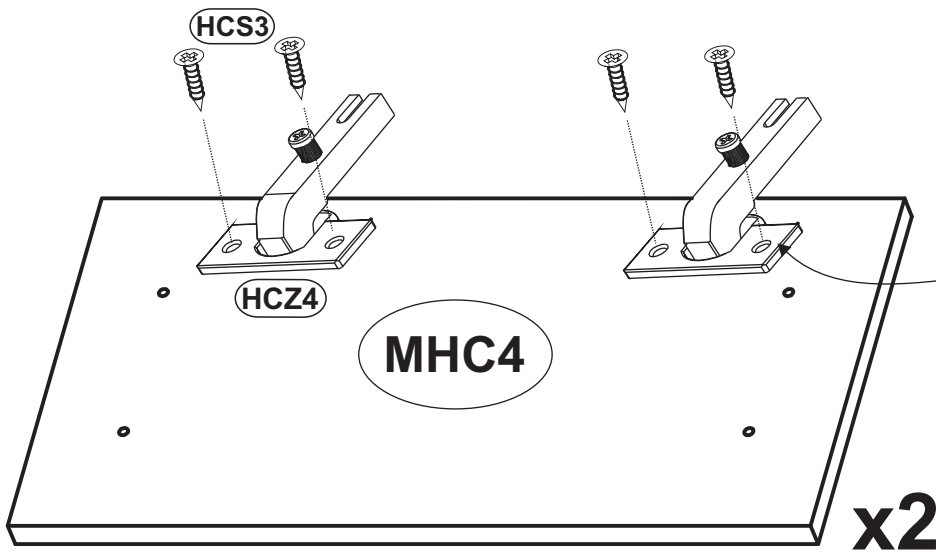
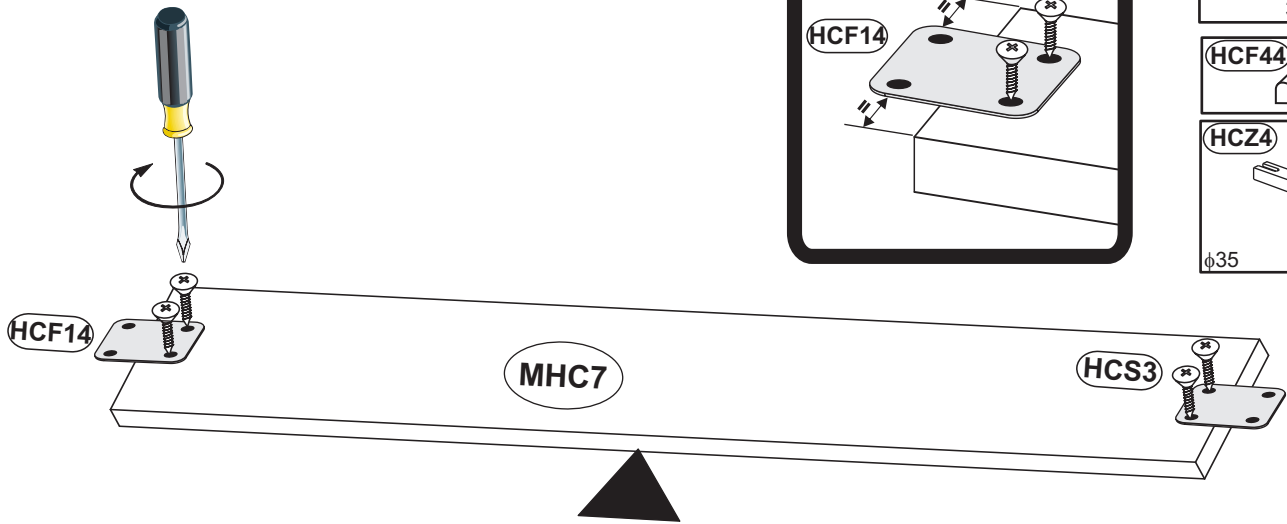
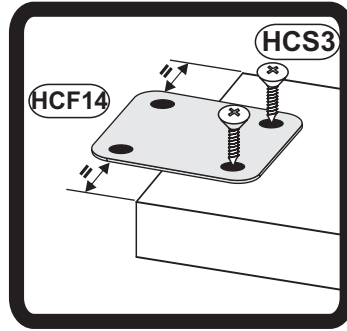



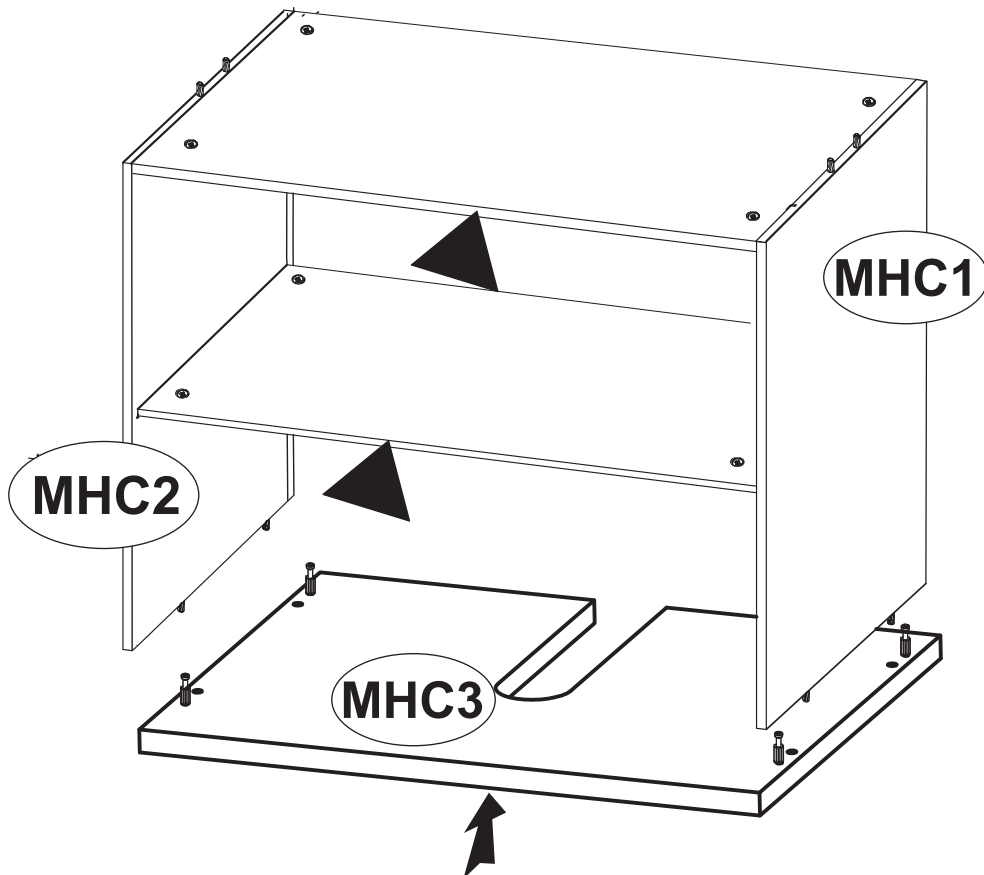
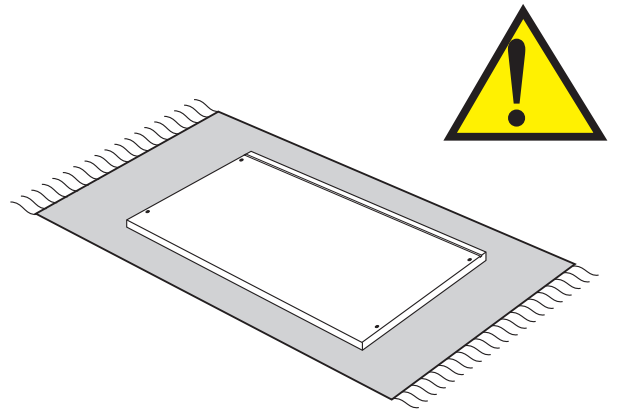
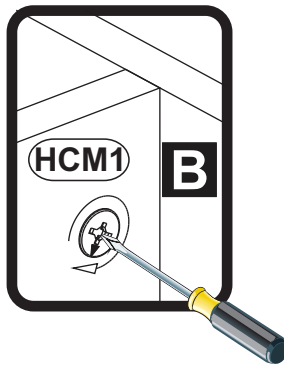
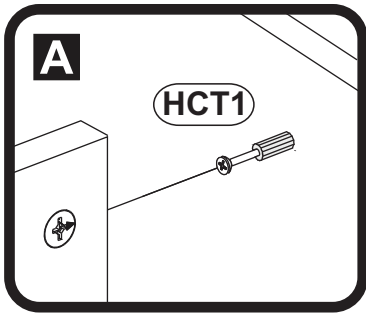
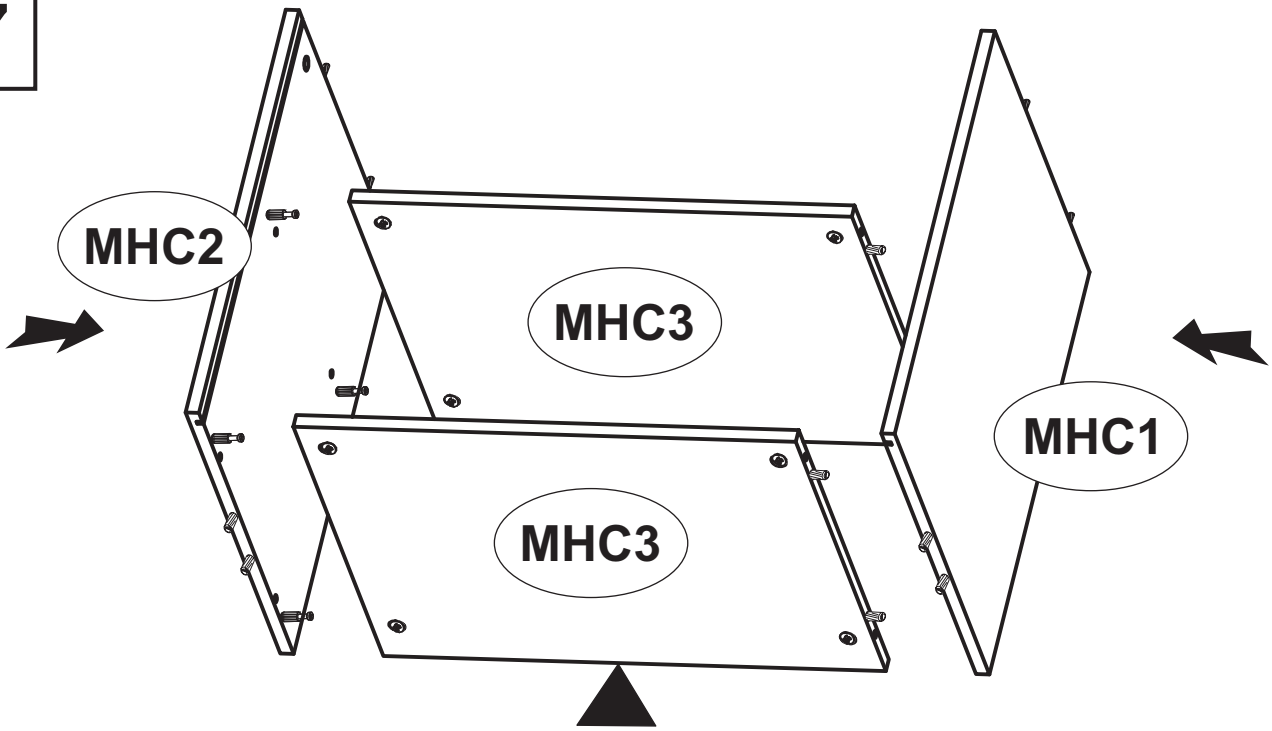

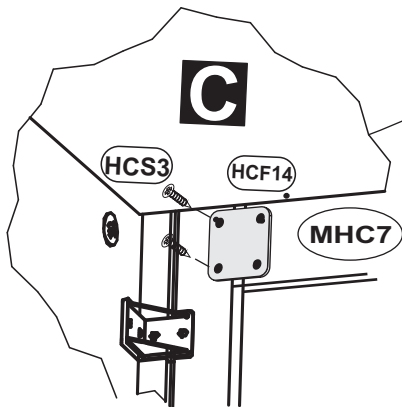
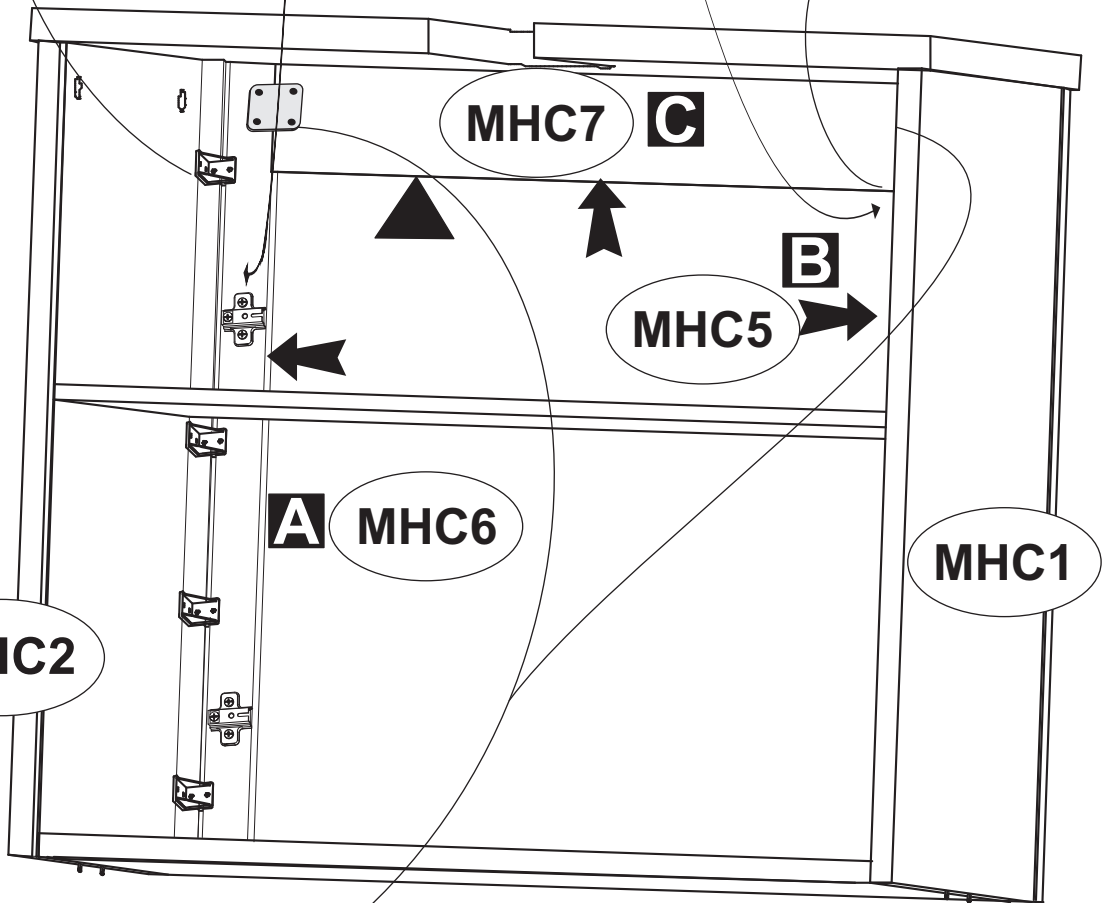
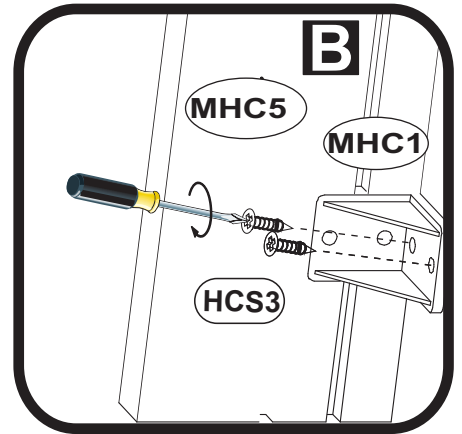
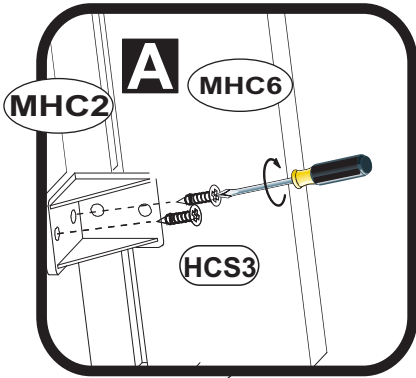
7



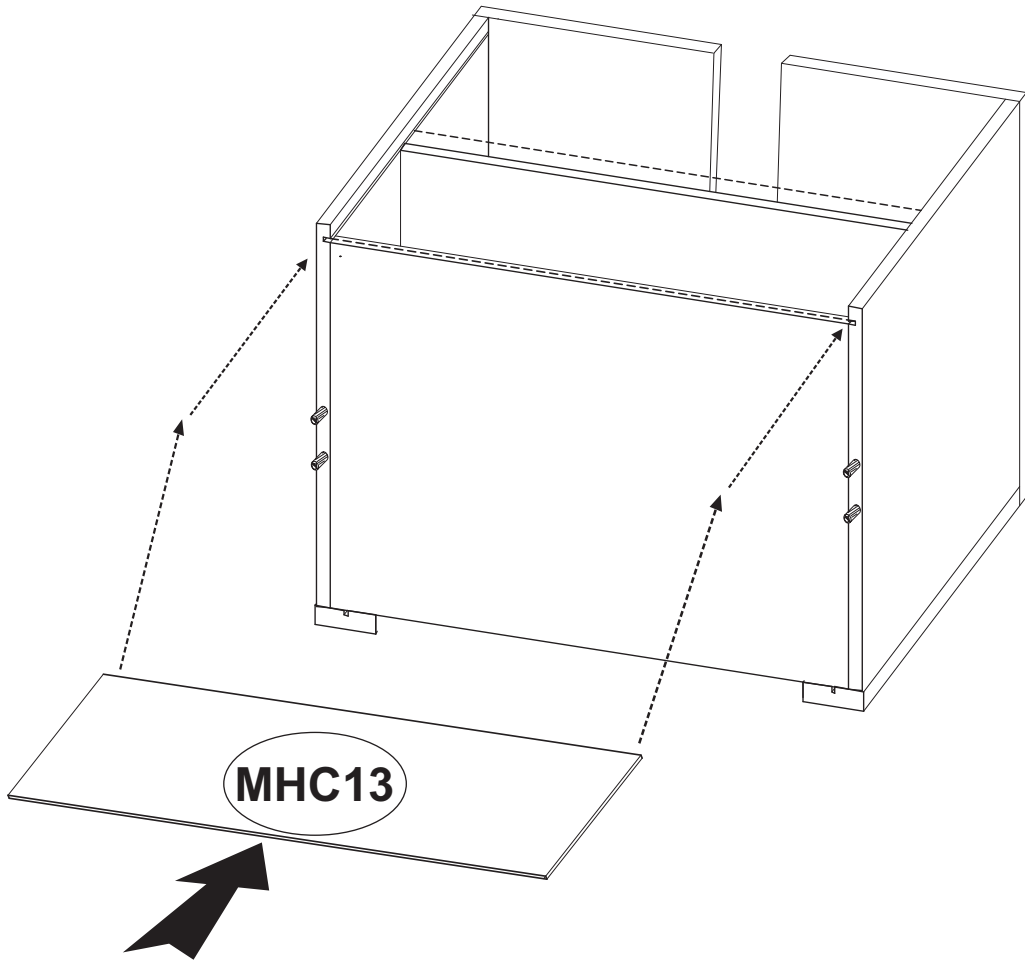

9



HCS3 	1011
3,5x13	x12
HCJ23 	1302
	x4
HCP6 	1056
3x20	x8

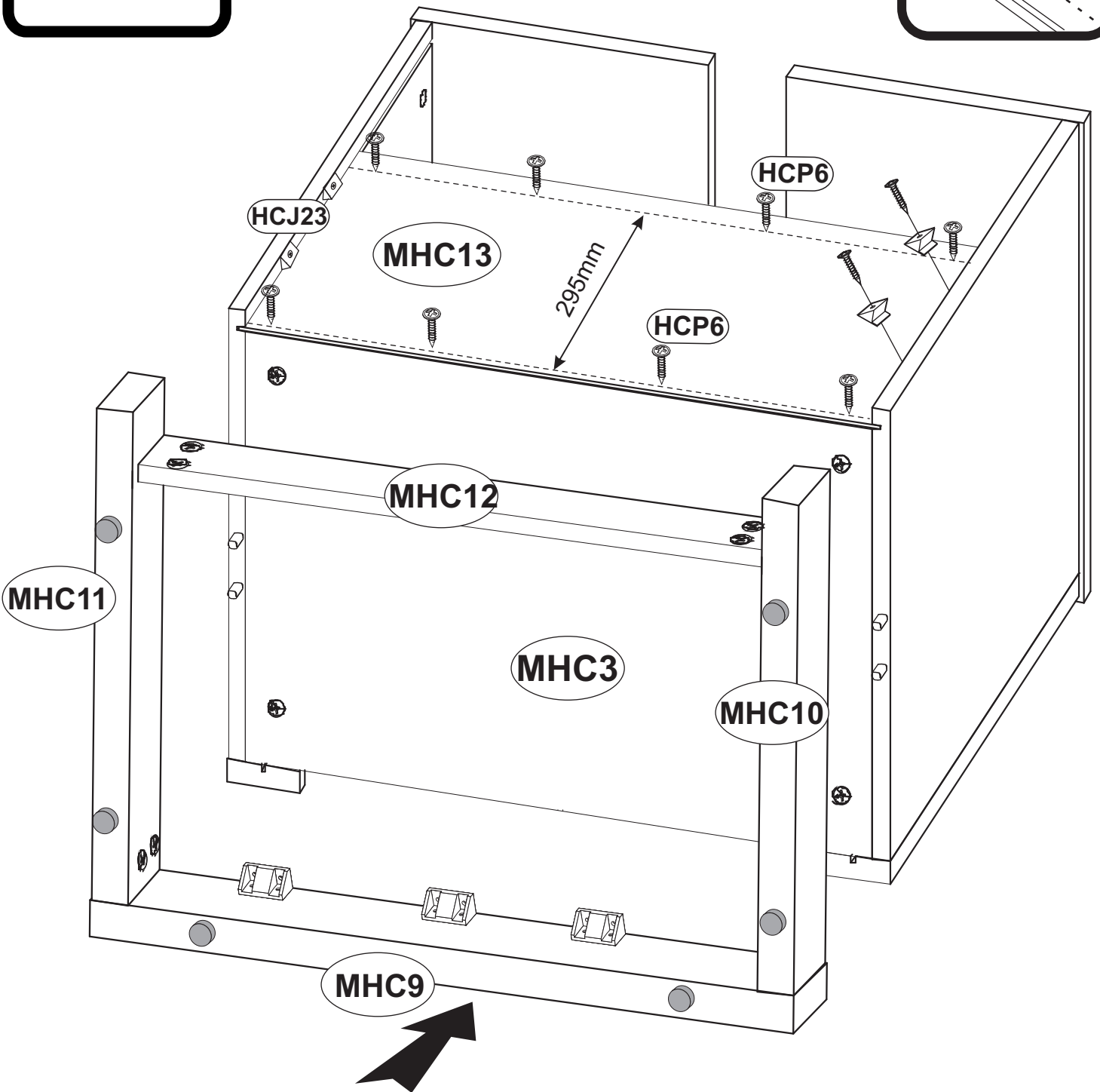
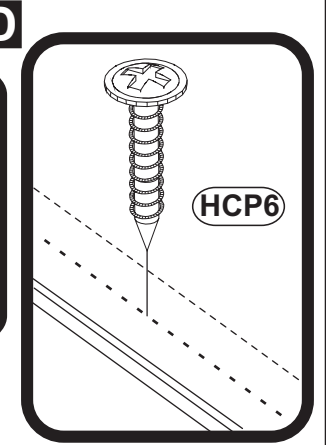
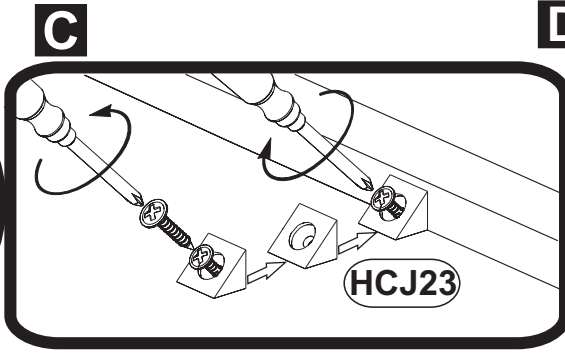
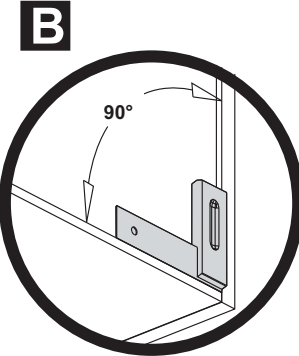
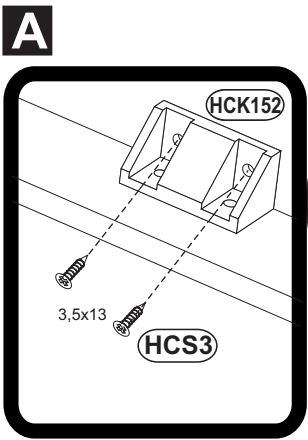

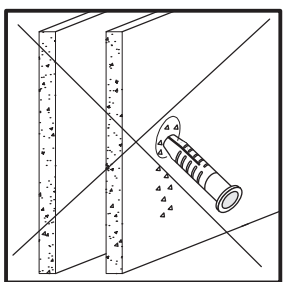
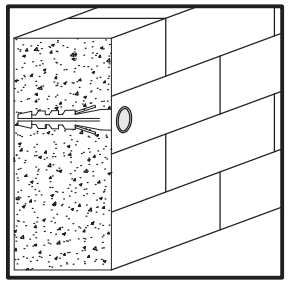
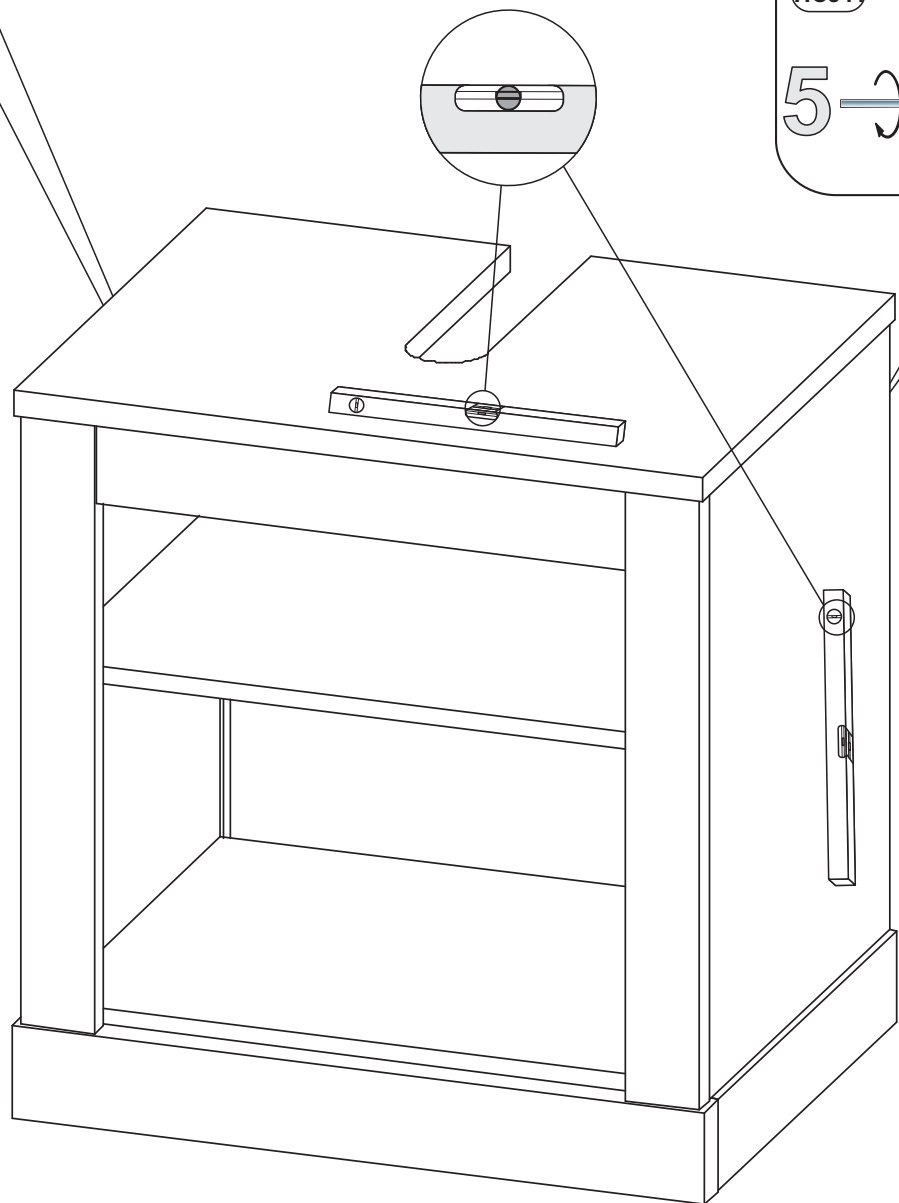
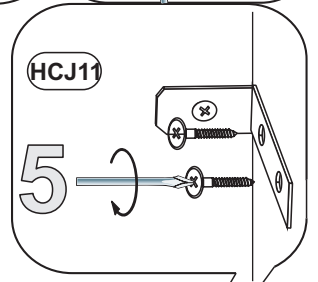
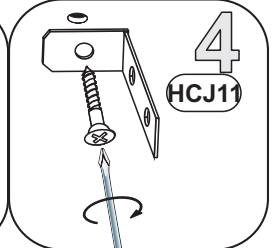
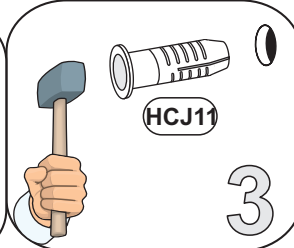
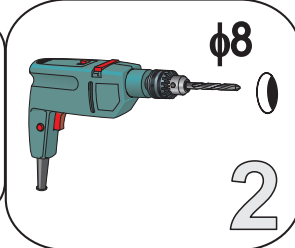
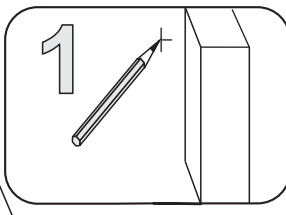
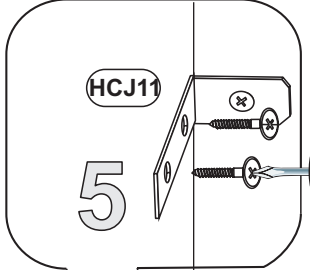
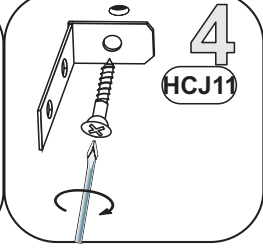
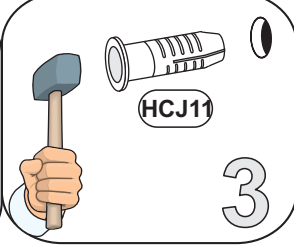
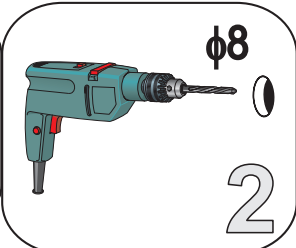
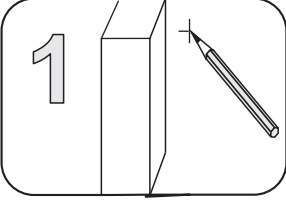

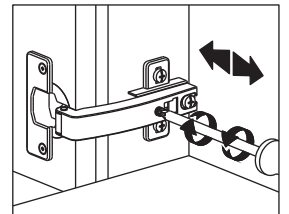
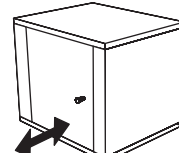
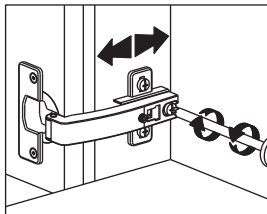
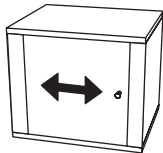
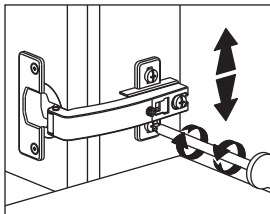
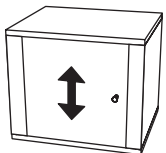
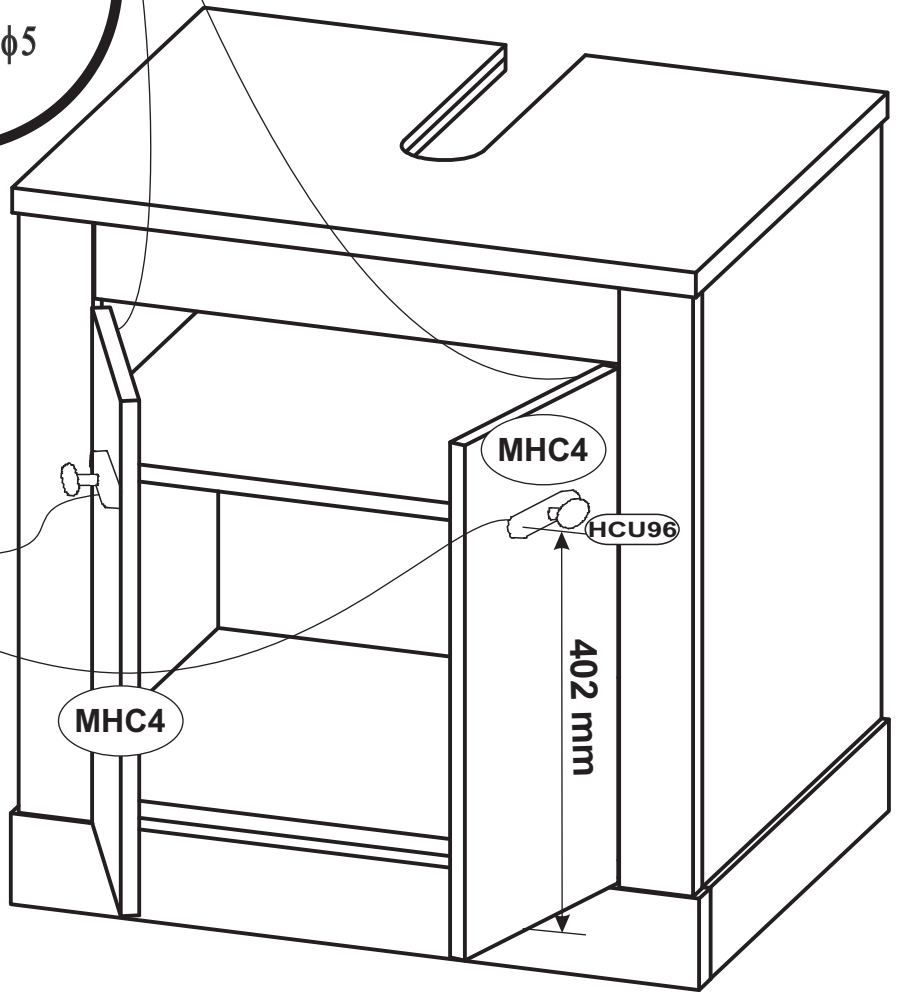
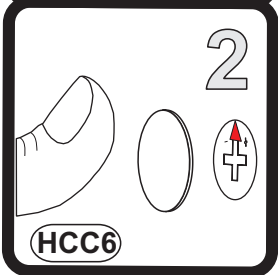
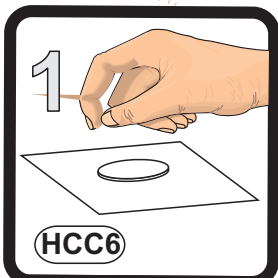
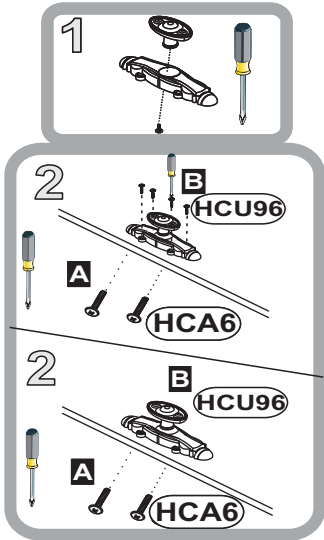
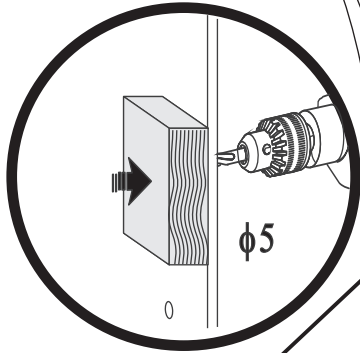
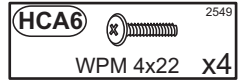
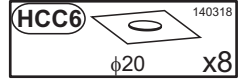
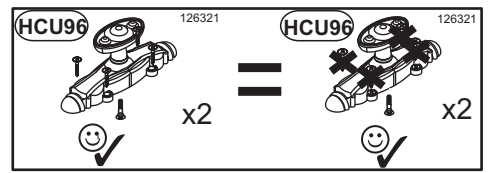
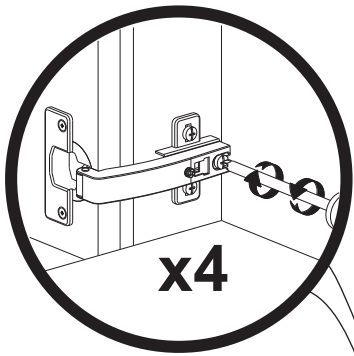

FLORENZ BAD 31

max.

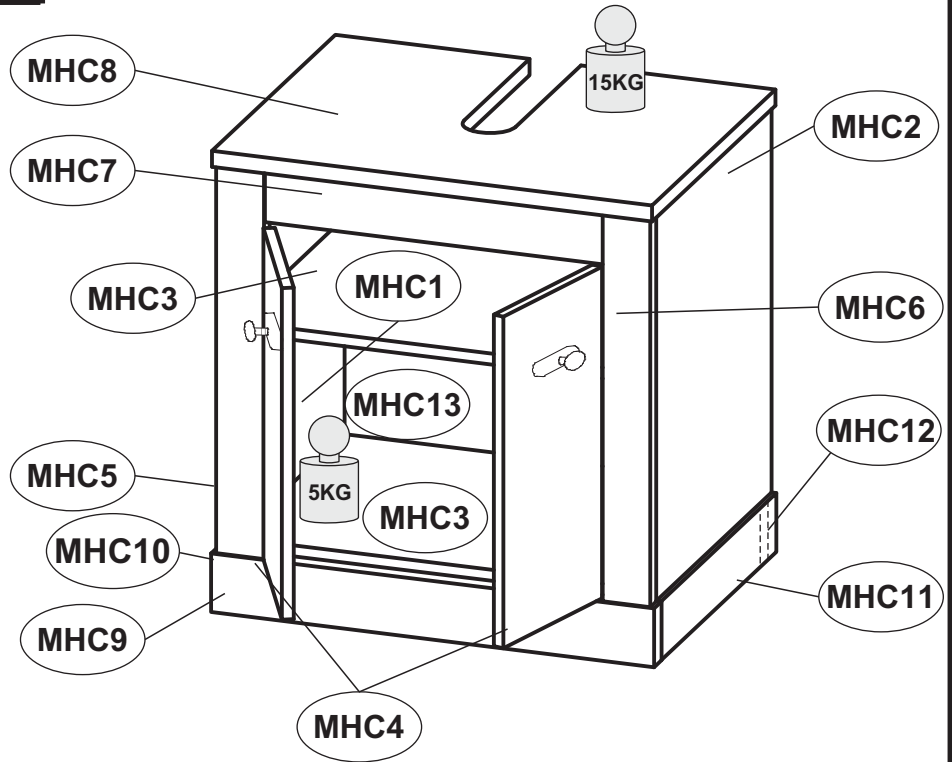
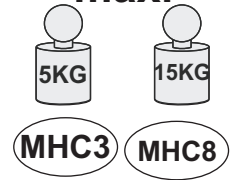

D

Unser Direktservice für Beschlagteile
Sollte Ihnen ein Beschlagteil fehlen, können Sie diese Servicekarte direkt an die untenstehende Adresse mailen. Wir können allerdings nur Beschlagteile auf diesem Wege verschicken. Sollten Sie eine andere Beanstandung an Ihrem Möbelstück haben, so wenden sie sich bitte direkt an Ihr Möbelhaus.

GB

Our direct order service for fitting
If a fitting part is missing, you can e-mail this service card directly to the address below. However, we can only send fitting parts in this way. If you have any other cause for complaint concerning your item of furniture, please contact your furniture store directly.

CZ

Naše přímé služby pro kování
Chybí-li vám nějaký díl z kování, můžete tuto servisní kartu odeslat e-mailem přímo na níže uvedenou adresu. Touto cestou však můžeme rozeslat jen díly kování. Pokud byste reklamovali jiný díl nábytku, obraťte se přímo na svého prodejce nábytku.

F

Bien étudier la notice de montage
S'il vous manque une ferrure, veuillez envoyer directement la présente carte service à l'adresse e-mail indiquée ci-dessous. Cependant, ceci nous permet uniquement d'envoyer des ferrures. Pour tout autre type de réclamation concernant votre meuble, veuillez contacter directement votre magasin d'ameublement.

I

Il nostro servizio diretto per l'ordine della ferramenta
Qualora Vi dovesse mancare un pezzo di fissaggio, allora Vi preghiamo di inviare questa carta di servizio immediatamente all'indirizzo sottostante. Possiamo inviare i pezzi di fissaggio solamente per mezzo di questo procedimento. Qualora dovete avere qualche altra reclamazione in merito al mobile, allora Vi preghiamo di rivolgerVi direttamente al Vostro Negozio di mobili.

BG

Нашата директна услуга за обков
Ако липсват части от комплекта, потърнете настоящата сервисна карта и ни я изпратете на e-mail адреса, посочен по-долу. По този начин можем да доставяме само липсващи елементи от обкова. Ако установите други дефекти по мебелите, Ви съветваме да се обърнете към мебелната къща/магазин, от който сте закупили стоката.

NL

Onze directservice voor losse onderdelen
Wanneer er een onderdeel ontbreekt, kunt u deze servicekaart direct aan onderstaand e-mailadres sturen. Wij kunnen langs deze weg echter alleen beslagdelen versturen. Mocht u een ander probleem aan uw meubel hebben, verzoeken wij u contact op te nemen met uw meubeldealer.

PL

Nasz bezpośredni serwis części montażowych
Jeżeli brakuje części koniecznych do montażu, prosimy o przesłanie nam niniejszej karty serwisowej na niżej podany adres e-mailowy. W ten sposób możemy przesyłać Państwu tylko brakujące części. W przypadku innych reklamacji dotyczących mebla, prosimy zgłosić się do salonu meblowego, w którym został dokonany zakup.

HR

Servis za okove
U slučaju da nedostaje neki od dijelova molimo vas da na dolje navedenu mail adresu pošaljete ovaj servisni obrazac. Na ovaj način mogu se dostaviti samo okovi. U slučaju da imate dodatne prigovore vezane uz komad namještaja molimo vas da se obratite izravno trgovini namještaja gdje je isti kupljen.

HU

Direktszolgáltatunk vasalatok esetén
Ha hiányzik egy vasalat, ezt a kártyát közvetlenül elküldheti az alább található címre. Azonban csakis vasalatosokat tudunk így küldeni. Amennyiben másfajta reklamáció áll fenn börtörarabját illetően, forduljon közvetlenül a boltjához.

SK

Náš priamy servis pre časti kovania
Ak by Vám chýbala nejaká časť kovania, môžete poslať túto servisnú kartu poslať e-mailom na nižšie uvedenú adresu. Diely kovania vieme poslať iba týmto spôsobom. Ak by ste mali inú reklamáciu ohľadom Vášho nábytku, obráťte sa priamo na Vašu predajňu nábytku.

SLO

Naše direktno uslužne storitve za okovje
Če vam manjka kakšno okovje, lahko to servisno kartico pošljete po e-pošti direktno na spodnji naslov. Po tej poti vam lahko pošljemo samo okovje. Če želite reklamirati kakšen drug del pohištva, se obrnite neposredno na vašo trgovino pohištva.

RO

Service-ul nostru direct pentru feronerie
In cazul in care va lipsesste o piesa de feronerie puteti sa trimiteți direct această card de service prin e-mail la adresa de mai jos. Noi nu putem expedia piese de feronerie decât pe această cale. Dacă aveți o altă reclamație referitoare la piesa de mobilier, atunci vă rugăm să vă adresați direct la magazinul dvs. de mobilă.

RUS

Наш прямой сервис для поставок фурнитуры
Если окажется, что Вам не хватает того или иного элемента фурнитуры, Вы можете отправить сервисную карту по факсу непосредственно на нижеприведенный адрес электронной почты. Однако, таким образом мы можем переслать лишь фурнитуру. Если же у Вас возникнут иные претензии относительно приобретенной мебели, пожалуйста, обращайтесь непосредственно в организацию, осуществившую продажу.

S

Vår direktservice för beslagsdelar
Om du saknar en beslagsdel kan du skicka detta servicekort direkt till e-postadressen som anges nedan. Tänk på att detta är den enda möjligheten att skicka beslagsdelar till dig. Om du vill reklamera din möbel av en annan anledning måste du kontakta ditt möbelhus direkt.

ES











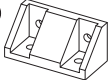



Nuestro servicio directo para accesorios
Si le falta algún accesorio, puede enviar esta tarjeta de servicio directamente a la siguiente dirección. No obstante, por este método solo podemos enviar accesorios. Si tiene alguna otra objeción sobre su mueble, consulte directamente con su mueblería.

TR

Donatılar için doğrudan servisimiz
Bir donatınız eksikse bu servis kartını doğrudan aşağıda bulunan adrese doğrudan mail yazabilirsiniz. Sadece bu yolla donatılar gönderilebilir. Mobilyanızda başka şikayetleriniz varsa lütfen doğrudan mobilya satıcınıza danışın.

MHC1	528	435	15	1/1
MHC2	528	435	15	1/1
MHC3	560	414	15	1/1
MHC4	452	226	15	1/1
MHC5	528	65	22	1/1
MHC6	528	65	22	1/1
MHC7	462	70	18	1/1
MHC8	600	462	22	1/1
MHC9	604	80	28	1/1
MHC10	428	80	28	1/1
MHC11	428	80	32	1/1
MHC12	539	70	15	1/1
MHC13	325	572	3	1/1

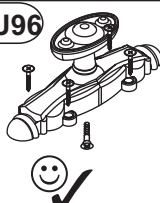
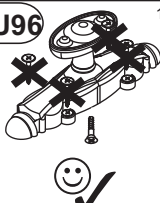
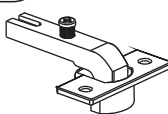
FLORENZ BAD 31

HCB1 8x28 X... 1018		HCK152 X... 81556	
HCF14 X... 1021		HCC6 φ20 X... 140318	
HCM1 X... 123894		HCF36 X... 1305	
HCT1 X... 11809		HCK13 X... 49716	
HCJ23 X... 1302		HCA6 WPM 4x22 X... 2549	
HCP6 3x20 X... 1056		HCJ11 X... 1267	
HCD14 H4 X... 23515		HCS3 3,5x13 X... 1011	
HCU96 X... 126321		HCU96 X... 126321	
HCZ4 φ35 90° X... 49365		HCF44 X... 116795	
HCG69 X... 147119			

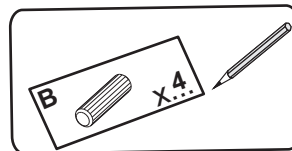

D Unser Direktservice für Beschlagteile
Sollte Ihnen ein Beschlagteil fehlen, können Sie diese Servicekarte direkt an die untenstehende Adresse mailen. Wir können allerdings nur Beschlagteile auf diesem Wege verschicken. Sollten Sie eine andere Beanstandung an Ihrem Möbelstück haben, so wenden Sie sich bitte direkt an Ihr Möbelhaus.

GB Our direct order service for fitting
If a fitting part is missing, you can e-mail this service card directly to the address below. However, we can only send fitting parts in this way. If you have any other cause for complaint concerning your item of furniture, please contact your furniture store directly.

CZ Naše přímé služby pro kování
Chybí-li vám nějaký díl z kování, můžete tuto servisní kartu odeslat e-mailem přímo na níže uvedenou adresu. Touto cestou však můžeme rozeslat jen díly kování. Pokud byste reklamovali jiný díl nábytku, obraťte se přímo na svého prodejce nábytku.

F Bien étudier la notice de montage
S'il vous manque une ferrure, veuillez envoyer directement la présente carte service à l'adresse e-mail indiquée ci-dessous. Cependant, ceci nous permet uniquement d'envoyer des ferrures. Pour tout autre type de réclamation concernant votre meuble, veuillez contacter directement votre magasin d'ameublement.

I Il nostro servizio diretto per l'ordine della ferramenta
Qualora Vi dovesse mancare un pezzo di fissaggio, allora Vi preghiamo di inviare questa carta di servizio immediatamente all'indirizzo sottostante. Possiamo inviare i pezzi di fissaggio solamente per mezzo di questo procedimento. Qualora dovreste avere qualche altra reclamazione in merito al mobile, allora Vi preghiamo di rivolgerVi direttamente al Vostro Negozio di mobili.

BG Нашата директна услуга за обкова
Ако липсват части от комплекта, попълнете настоящата сервисна карта и ни я изпратете на e-mail адреса, посочен по-долу. По този начин можем да доставяме само липсващи елементи от обкова. Ако установите други дефекти по мебелите, Ви съветваме да се обърнете към мебелната къща/магазин, от който сте закупили стоката.

NL Onze directservice voor losse onderdelen
Wanneer er een onderdeel ontbreekt, kunt u deze servicekaart direct aan onderstaand e-mailadres sturen. Wij kunnen alleen deze weg echter alleen beslagdelen versturen. Mocht u een ander probleem aan uw meubel hebben, verzoeken wij u contact op te nemen met uw meubeldealer.

PL Nasz bezpośredni serwis czeski montażowych
Jeżeli brakuje części koniecznych do montażu, prosimy o przesłanie nam niniejszej karty serwisowej na niżej podany adres e-mailowy. W ten sposób możemy przesłać Państwu tylko brakujące części. W przypadku innych reklamacji dotyczących mebla, prosimy zgłosić się do salonu meblowego, w którym został dokonany zakup.

HR Servis za okove
U slučaju da nedostaje neki od dijelova molimo vas da na dolje navedenu mail adresu pošaljete ovaj servisni obrazac. Na ovaj način mogu se dostaviti samo okovi. U slučaju da imate dodatne prigovore vezane uz komad namještaja molimo vas da se obratite izravno trgovini namještaja gdje je isti kupljen.

HU Direktszolgálatunk vasalatok esetén
Ha hiányzik egy vasalat, ezt a kártyát közvetlenül elküldheti az alább található címre. Azonban csakis vasalatoskat tudunk így küldeni. Amennyiben másfajta reklamáció áll fenn bútorárbaját illetően, forduljon közvetlenül a bútorházhöz.

SK Naš priamy servis pre časti kovania
Ak by Vám chýbala nejaká časť kovania, môžete poslať túto servisnú kartu poslať e-mailom na nižšie uvedenú adresu. Diely kovania vieme poslať iba týmto spôsobom. Ak by ste mali inú reklamáciu ohľadom Vášho nábytku, obraťte sa priamo na Vašu predajňu nábytku.

SLO Naše direktno uslužbne storitve za okovje
Če vam manjka kakšno okovje, lahko to servisno kartico pošljete po e-pošti direktno na spodnji naslov. Po tej poti vam lahko pošljemo samo okovje. Če želite reklamirati kakšen drug del pohištva, se obrnite neposredno na vašo trgovino pohištva.

RO Service-ul nostru direct pentru feronerie
In cazul in care va lipsesite o piesa de feronerie puteti să trimiteți direct acest card de service prin e-mail la adresa de mai jos. Noi nu putem expedia piese de feronerie decât pe această cale. Dacă aveți o altă reclamație referitoare la piesa de mobilier, atunci vă rugăm să vă adresați direct la magazinul dvs. de mobilă.

RUS Наш прямой сервис для поставок фурнитуры
Если окажется, что Вам не хватает того или иного элемента фурнитуры, Вы можете отправить сервисную карту по факсу непосредственно на нижеприведенный адрес электронной почты. Однако, таким образом мы можем пересылать лишь фурнитуру. Если же у Вас возникнут иные претензии относительно приобретенной мебели, пожалуйста, обращайтесь непосредственно в организацию, осуществившую продажу.

S Vir direktservice för beslagsdelar
Om du saknar en beslagsdel kan du skicka detta servicekort direkt till e-postadressen som anges nedan. Tänk på att detta är den enda möjligheten att skicka beslagsdelar till dig. Om du vill reklamera din möbel av en annan anledning måste du kontakta ditt möbelhus direkt.

ES Nuestro servicio directo para accesorios
Si le falta algún accesorio, puede enviar esta tarjeta de servicio directamente a la siguiente dirección. No obstante, por este método solo podemos enviar accesorios. Si tiene alguna otra objeción sobre su mueble, consulte directamente con su mueblería.

TR Donatılar için doğrudan servisimiz
Bir donatınız eksikse bu servis kartını doğrudan aşağıda bulunan adrese doğrudan mail yazabilirsiniz. Sadece bu yolla donatılar gönderiliriz. Mobilyanızda başka şikayetleriniz varsa lütfen doğrudan mobilya satıcınıza danışın.

FLORENZ BAD 76

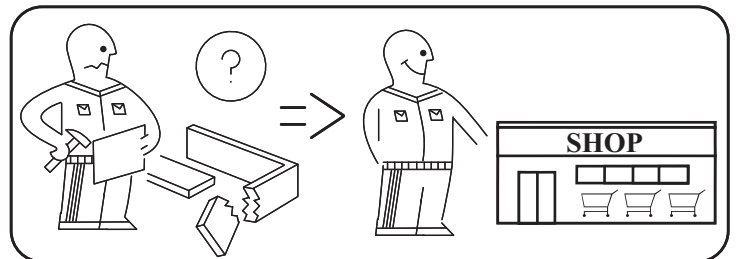
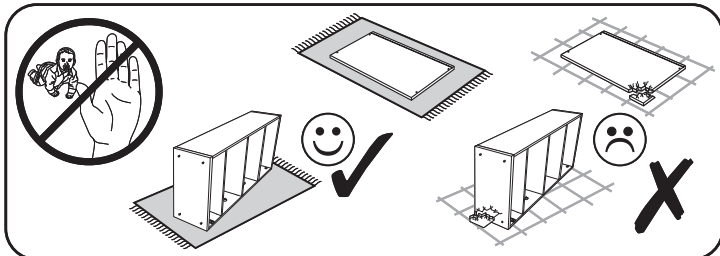
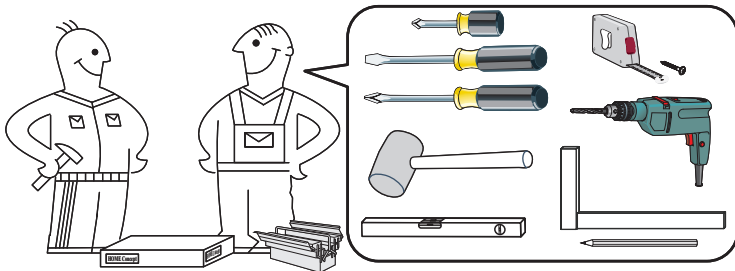
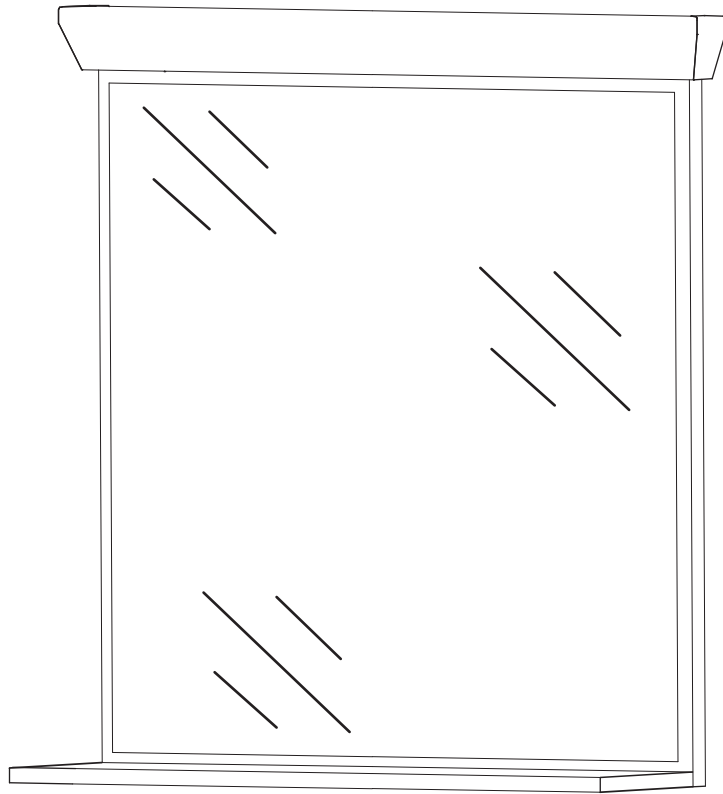

FLORENZ BAD 76

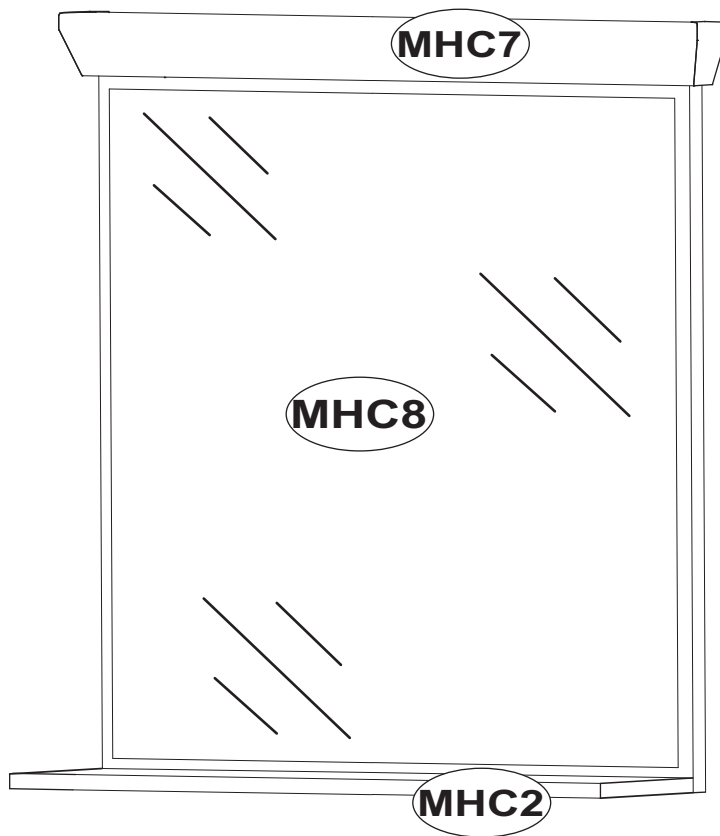

MHC2	538	135	22	1/1
MHC7	600	43	65	1/1
MHC8	719	540	18	1/1

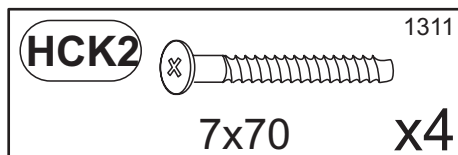
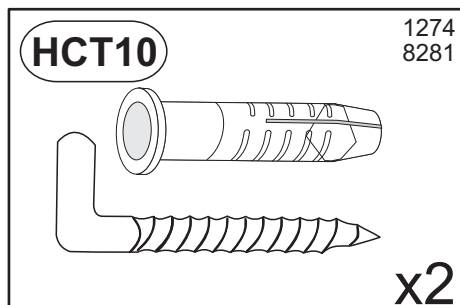

1

HCK2
7x70 x4

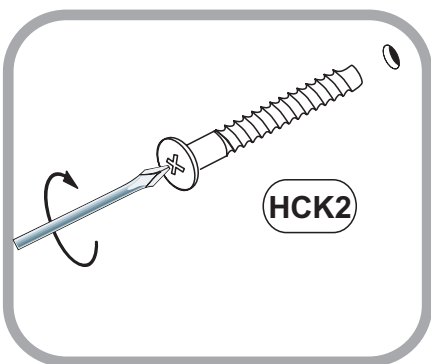
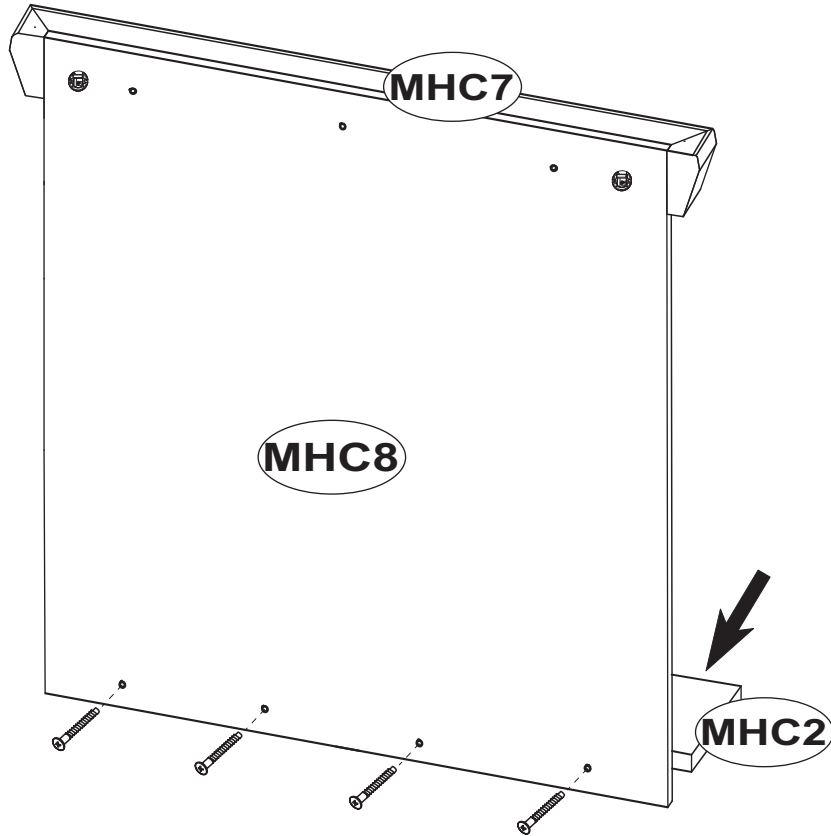

2

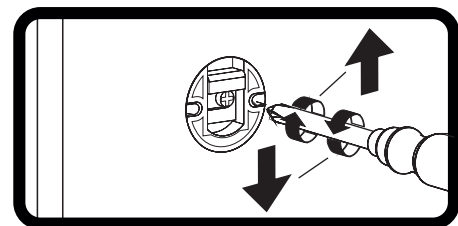
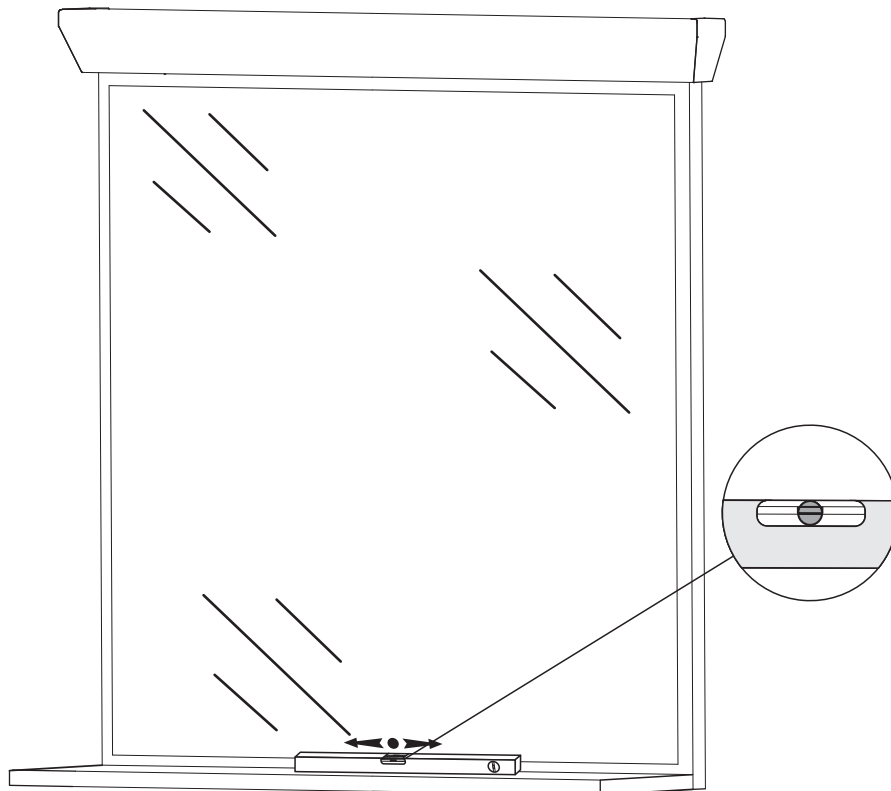
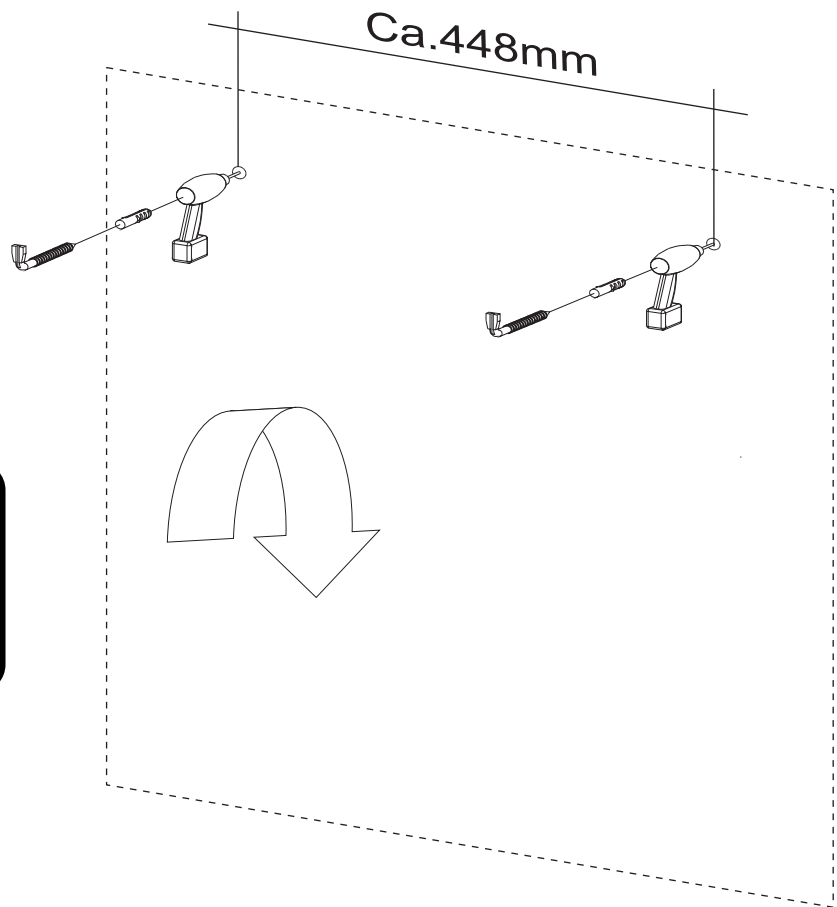
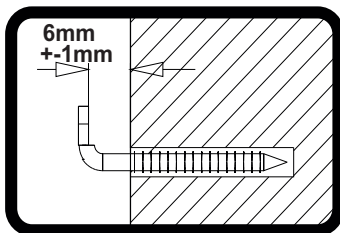
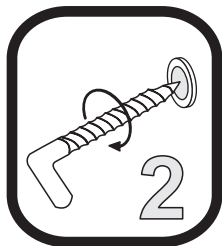
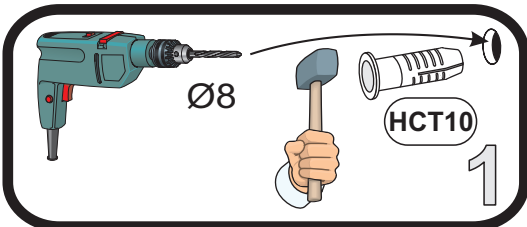
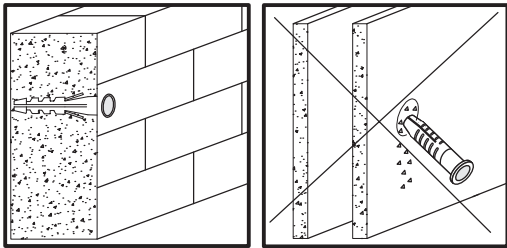
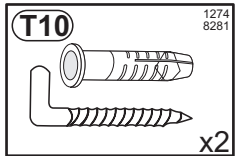

FLORENZ BAD 76

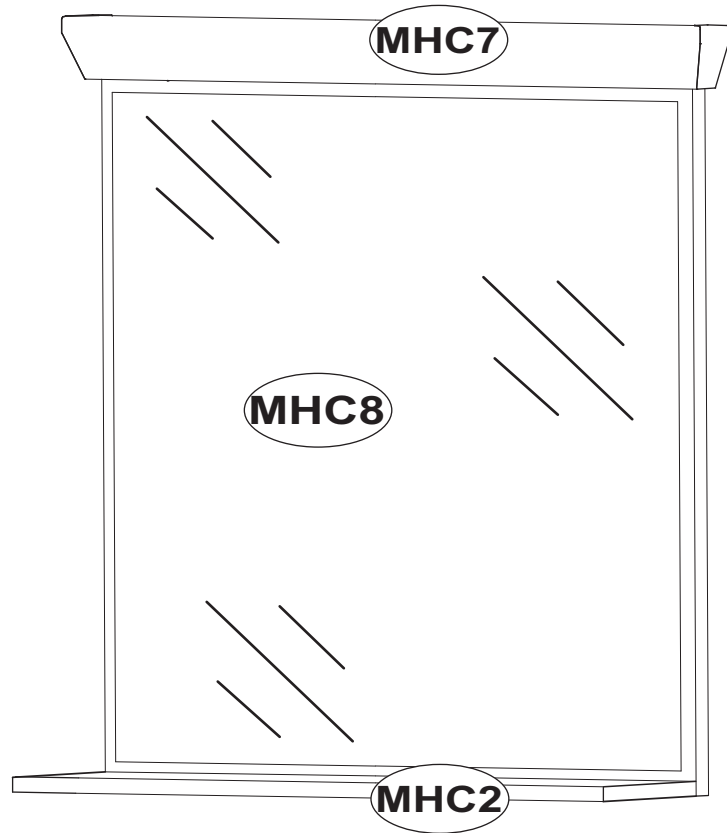

D

Unser Direktservice für Beschlagteile
Sollte Ihnen ein Beschlagteil fehlen, können Sie diese Servicekarte direkt an die untenstehende Adresse mailen. Wir können allerdings nur Beschlagteile auf diesem Wege verschicken. Sollten Sie eine andere Beanstandung an Ihrem Möbelstück haben, so wenden Sie sich bitte direkt an Ihr Möbelhaus.

Our direct order service for fitting

GB If a fitting part is missing, you can e-mail this service card directly to the address below. However, we can only send fitting parts in this way. If you have any other cause for complaint concerning your item of furniture, please contact your furniture store directly.

CZ

Naše přímé služby pro kování
Chybí-li vám nějaký díl z kování, můžete tuto servisní kartu odeslat e-mailem přímo na níže uvedenou adresu. Touto cestou však můžeme zosílat jen díly kování. Pokud byste reklamovali jiný díl nábytku, obraťte se přímo na svého prodejce nábytku.

F

Bien étudier la notice de montage
S'il vous manque une ferrure, veuillez envoyer directement la présente carte service à l'adresse e-mail indiquée ci-dessous. Cependant, ceci nous permet uniquement d'envoyer des ferrures. Pour tout autre type de réclamation concernant votre meuble, veuillez contacter directement votre magasin d'ameublement.

I

Il nostro servizio diretto per l'ordine della ferramenta
Qualora Vi dovesse mancare un pezzo di fissaggio, allora Vi preghiamo di inviare questa carta di servizio immediatamente all'indirizzo sottostante. Possiamo inviare i pezzi di fissaggio solamente per mezzo di questo procedimento. Qualora dovete avere qualche altra reclamazione in merito al mobile, allora Vi preghiamo di rivolgerVi direttamente al Vostro Negozio di mobili.

BG

Нашата директна услуга за обикво
Ако липсват части от комплекта, попълнете настоящата сервисна карта и ни я изпратете на e-mail адреса, посочен по-долу. По този начин можем да доставяме само липсващи елементи от обикво. Ако установите други дефекти по мебелите, Ви съветваме да се обърнете към мебелната къща/магазин, от който сте закупили стоката.

NL

Onze directservice voor losse onderdelen
Wanneer er een onderdeel ontbreekt, kunt u deze servicekaart direct aan onderstaand e-mailadres sturen. Wij kunnen langs deze weg echter alleen beslagdelen versturen. Mocht u een ander probleem aan uw meubel hebben, verzoeken wij u contact op te nemen met uw meubeldealer.

PL

Nasz bezpośredni serwis części montażowych
Jeżeli brakuje części koniecznych do montażu, prosimy o przesłanie nam niniejszej karty serwisowej na niżej podany adres e-mailowy. W ten sposób możemy przesyłać Państwu tylko brakujące części. W przypadku innych reklamacji dotyczących mebla, prosimy zgłosić się do salonu meblowego, w którym został dokonany zakup.

HR

Servis za okove
U slučaju da nedostaje neki od dijelova molimo vas da na dolje navedenu mail adresu pošaljete ovaj servisni obrazac. Na ovaj način mogu se dostaviti samo okovi. U slučaju da imate dodatne prigovore vezane uz komad namještaja molimo vas da se obratite izravno trgovini namještaja gdje je isti kupljen.

HU

Direktszoqlátatunk vasalatok esetén
Ha hiányzik egy vasalat, ezt a kártyát közvetlenül elküldheti az alább található címre. Azonban csak a vasalatoskat tudunk így küldeni. Amennyiben másfajta reklamációt áll fenn bútordarabját illetően, forduljon közvetlenül a bútortházhoz.

SK

Náš priamy servis pro častí kovania
Ak by Vám chýbala nejaká časť kovania, môžete poslať túto servisnú kartu poslať e-mailom na nižšie uvedenú adresu. Diely kovania vieme poslať iba týmto spôsobom. Ak by ste mali inú reklamáciu ohľadom Vašho nábytku, obraťte sa priamo na Vašu predajňu nábytku.

SLO

Naše direktne uslužne storilve za okovje
Če vam manjka kakšno okovje, lahko to servisno kartico pošljete po e-pošti direktno na spodnji naslov. Po tej poti vam lahko pošljemo samo okovje. Če želite reklamirati kakšen drug del pohištva, se obrnite neposredno na vašo trgovino pohištva.

RO

Serviciu-ul nostru direct pentru feronerie
În cazul în care vă lipsește o piesă de feronerie puteți să trimiteți direct acest card de service prin e-mail la adresa de mai jos. Noi nu putem expedia piese de feronerie decât pe această cale. Dacă aveți o altă reclamație referitoare la piesa de mobilier, atunci vă rugăm să vă adresați direct la magazinul dvs. de mobilă.

RUS

Наш прямой сервис для поставок фурнитуры
Если окажется, что Вам не хватает того или иного элемента фурнитуры, Вы можете отправить сервисную карту по факсу непосредственно на нижеприведенный адрес электронной почты. Однако, таким образом мы можем переслать лишь фурнитуру. Если же у Вас возникнут иные претензии относительно приобретенной мебели, пожалуйста, обращайтесь непосредственно в организацию, осуществившую продажу.

S

Vir direktservice för beslagsdelar
Om du saknar en beslagsdel kan du skicka detta servicekort direkt till e-postadressen som anges nedan. Tänk på att detta är den enda möjligheten att skicka beslagsdelar till dig. Om du vill reklamera din möbel av en annan anledning måste du kontakta ditt möbelhus direkt.

ES

Nuestro servicio directo para accesorios
Si le falta algún accesorio, puede enviar esta tarjeta de servicio directamente a la siguiente dirección. No obstante, por este método solo podemos enviar accesorios. Si tiene alguna otra objeción sobre su mueble, consulte directamente con su mueblería.

TR

Donatılar için doğrudan servisimiz
Bir donatınız eksikse bu servis kartını doğrudan aşağıda bulunan adrese doğrudan mail yazabilirsiniz. Sadece bu yolla donatıları gönderilebilir. Mobilyanızda başka şikayetleriniz varsa lütfen doğrudan mobilya satıcınıza danışın.

MHC2	538	135	22	1/1
MHC7	600	43	65	1/1
MHC8	719	540	18	1/1

FLORENZ BAD 76

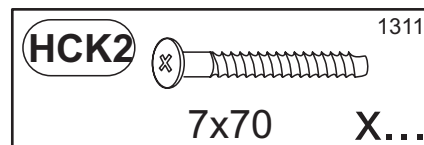
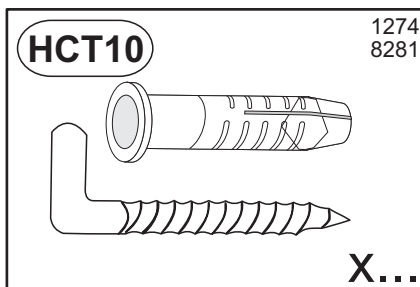

Unser Direktservice für Beschlagteile

Sollte Ihnen ein Beschlagteil fehlen, können Sie diese Servicekarte direkt an die untenstehende Adresse mailen. Wir können allerdings nur Beschlagteile auf diesem Wege verschicken. Sollten Sie eine andere Beanstandung an Ihrem Möbelstück haben, so wenden sie sich bitte direkt an Ihr Möbelhaus.

D

Our direct order service for fitting

If a fitting part is missing, you can e-mail this service card directly to the address below. However, we can only send fitting parts in this way. If you have any other cause for complaint concerning your item of furniture, please contact your furniture store directly.

GB

Naše přímé služby pro kování

Chybí-li vám nějaký díl z kování, můžete tuto servisní kartu odeslat e-mailem přímo na níže uvedenou adresu. Touto cestou však můžeme zoslat jen díly kování. Pokud byste reklamovali jiný díl nábytku, obraťte se přímo na svého prodejce nábytku.

CZ

Bien étudier la notice de montage

S'il vous manque une ferrure, veuillez envoyer directement la présente carte service à l'adresse e-mail indiquée ci-dessous. Cependant, ceci nous permet uniquement d'envoyer des ferrures. Pour tout autre type de réclamation concernant votre meuble, veuillez contacter directement votre magasin d'ameublement.

F

Il nostro servizio diretto per l'ordine della ferramenta

Qualora Vi dovesse mancare un pezzo di fissaggio, allora Vi preghiamo di inviare questa carta di servizio immediatamente all'indirizzo sottostante. Possiamo inviare i pezzi di fissaggio solamente per mezzo di questo procedimento. Qualora dovete avere qualche altra reclamazione in merito al mobile, allora Vi preghiamo di rivolgerVi direttamente al Vostro Negozio di mobili.

I

Нашата директна услуга за обкоя

Ако липсват части от комплекта, попълнете настоящата сервисна карта и ни я изпратете на e-mail адреса, посочен по-долу. По този начин можем да доставяме само липсващи елементи от обкоя. Ако установите други дефекти по мебелите, Ви съветваме да се обвърнете към мебелната къща/магазин, от който сте закупили стоката.

BG

Onze directservice voor losse onderdelen

Wanneer er een onderdeel ontbreekt, kunt u deze servicekaart direct aan onderstaand e-mailadres sturen. Wij kunnen langs deze weg echter alleen beslagdelen versturen. Mocht u een ander probleem aan uw meubel hebben, verzoeken wij u contact op te nemen met uw meubeldealer.

NL

Nasz bezpośredni serwis czeszcí montazowych

Jeżeli brakuje części koniecznych do montażu, prosimy o przesłanie nam niniejszej karty serwisowej na niżej podany adres e-mailowy. W ten sposób możemy przesać Państwu tylko brakujące części. W przypadku innych reklamacji dotyczących mebla, prosimy zgłosić się do salonu meblowego, w którym został dokonany zakup.

PL

Servis za okove

U slučaju da nedostaje neki od dijelova molimo vas da na dolje navedenu mail adresu pošaljete ovaj servisni obrazac. Na ovaj način mogu se dostaviti samo okovi. U slučaju da imate dodatne prigovore vezane uz komad namještaja molimo vas da se obratite izravno trgovini namještaja gdje je isti kupljen.

HR

Direktszolgalatunk vasalatok esetén

Ha hiányzik egy vasalat, ezt a kártyát közvetlenül elküldheti az alább található címre. Azonban csak vasalatoskat tudunk így küldeni. Amennyiben másfajta reklamáció áll fenn bútordarabját illetően, forduljon közvetlenül a bútortárházhoz.

HU

Náš priamy servis pre časti kovania

Ak by Vám chýbala nejaká časť kovania, môžete poslať túto servisnú kartu poslať e-mailom na nižšie uvedení adresu. Dieľy kovania vieme poslať iba týmto spôsobom. Ak by ste mali inú reklamáciu ohľadom Vášho nábytku, obráťte sa priamo na Vašu predajňu nábytku.

SK

Naše direktne uslužne storitve za okovje

Če vam manjka kakšno okovje, lahko to servisno kartico pošljete po e-pošti direktno na spodnji naslov. Po tej poti vam lahko pošljemo samo okovje. Če želite reklamirati kakšen drug del pohištva, se obrnite neposredno na vašo trgovino pohištva.

SLO

Service-ul nostru direct pentru feronerie

În cazul în care vă lipsește o piesă de feronerie puteți să trimiteți direct acest card de service prin e-mail la adresa de mai jos. Noi nu putem expedia piese de feronerie decât pe această cale. Dacă aveți o altă reclamație referitoare la piesa de mobilier, atunci vă rugăm să vă adresați direct la magazinul dvs. de mobilă.

RO

Наш прямой сервис для поставок фурнитуры

Если окажется, что Вам не хватает того или иного элемента фурнитуры, Вы можете отправить сервисную карту по факсу непосредственно на нижеприведенный адрес электронной почты. Однако, таким образом мы можем пересылать лишь фурнитуру. Если же у Вас возникнут иные претензии относительно приобретенной мебели, пожалуйста, обращайтесь непосредственно в организацию, осуществившую продажу.

RUS

Vir direktservice för beslagsdelar

Om du saknar en beslagsdel kan du skicka detta servicekort direkt till e-postadressen som anges nedan. Tänk på att detta är den enda möjligheten att skicka beslagsdelar till dig. Om du vill reklamera din möbel av en annan anledning måste du kontakta ditt möbelhus direkt.

S

Nuestro servicio directo para accesorios

Si le falta algún accesorio, puede enviar esta tarjeta de servicio directamente a la siguiente dirección. No obstante, por este método solo podemos enviar accesorios. Si tiene alguna otra objeción sobre su mueble, consulte directamente con su mueblería.

ES

Donatilar için doğrudan servisimiz

Bir donatınız eksikse bu servis kartını doğrudan aşağıda bulunan adrese doğrudan mail yazabilirsiniz. Sadece bu yolla donatıları gönderebiliriz. Mobilyanızda başka şikayetleriniz varsa lütfen doğrudan mobilya satıcınıza danışın.

TR

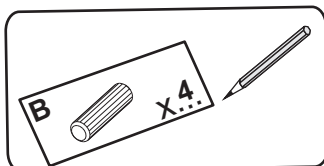

FLORENZ BAD 12

Option L



Option R

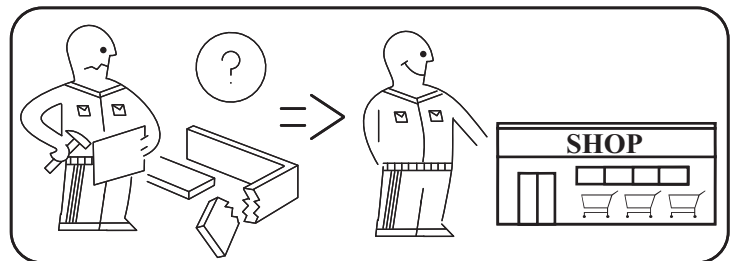
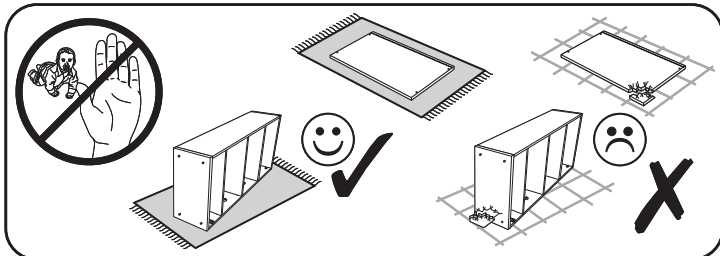
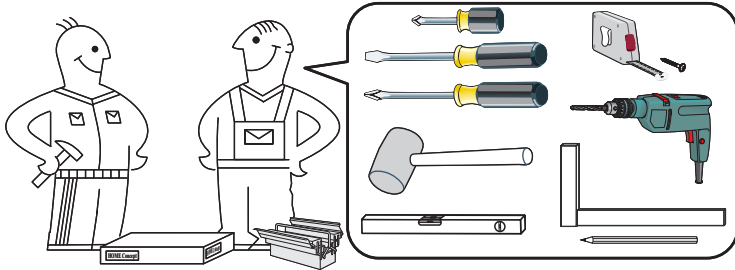
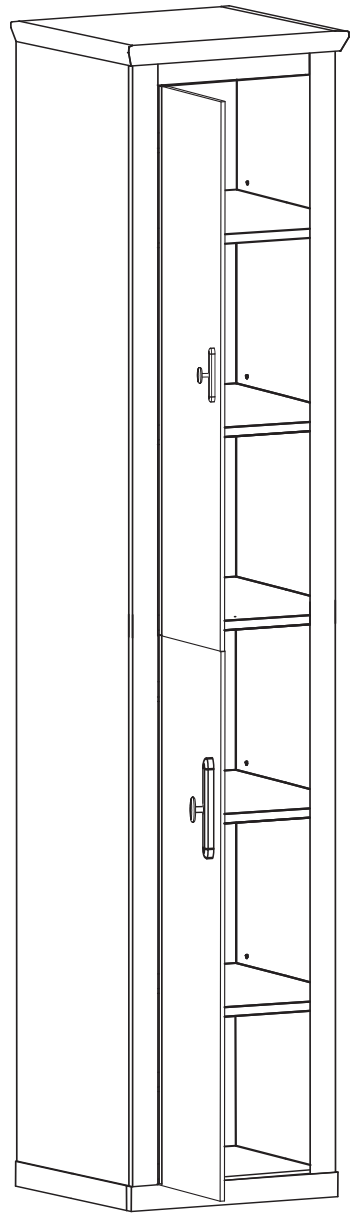
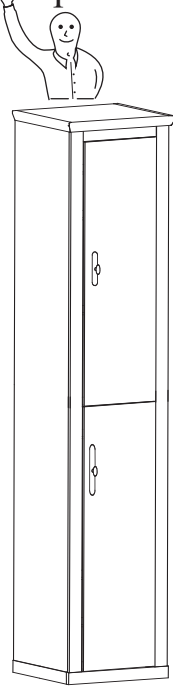

FLORENZ BAD 12

max.



MHC3

MHC4

MHC9

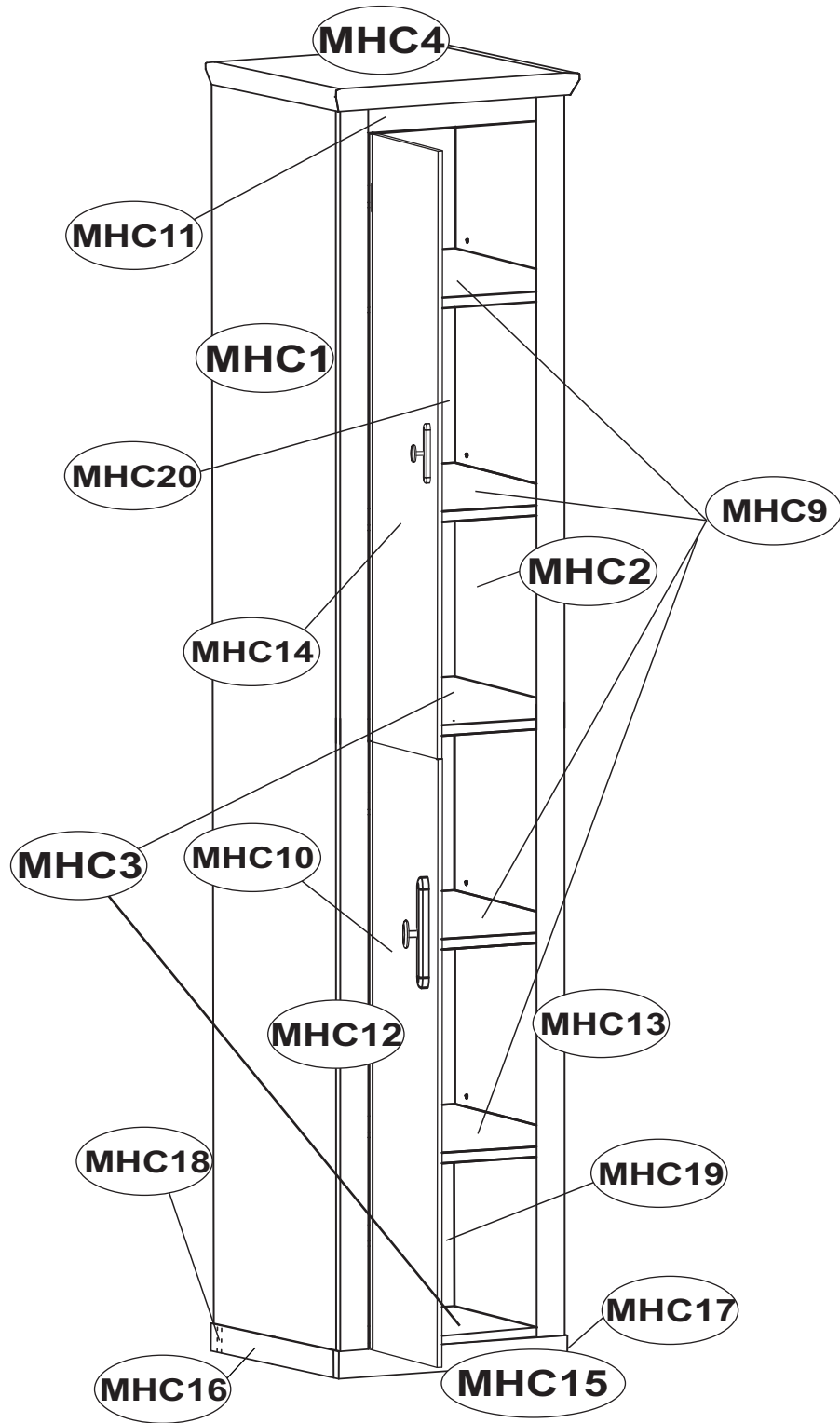



MHC1	1905	298	15	2/2
MHC2	1905	298	15	2/2
MHC3	329	277	15	1/2
MHC4	420	350	65	1/2
MHC9	328	267	15	1/2
MHC10	888	225	15	2/2
MHC11	231	120	18	1/2
MHC12	1905	65	22	2/2

MHC13	1905	65	22	2/2
MHC14	888	225	15	2/2
MHC15	373	80	32	1/2
MHC16	291	80	32	1/2
MHC17	291	80	32	1/2
MHC18	308	70	15	1/2
MHC19	892	341	3	2/2
MHC20	1019	341	3	2/2

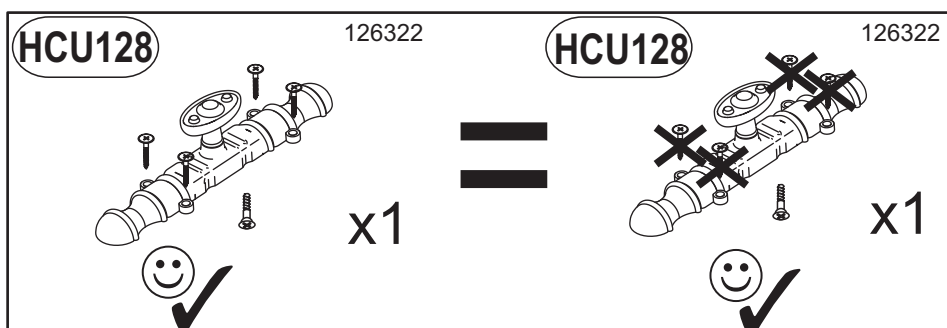
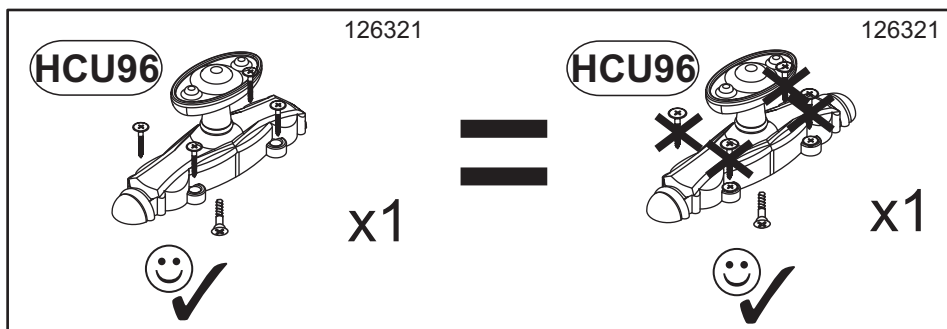
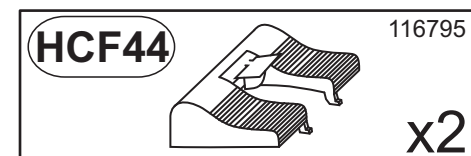
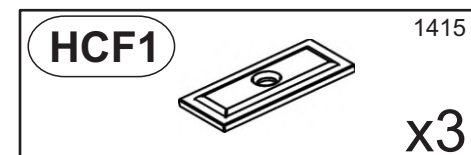
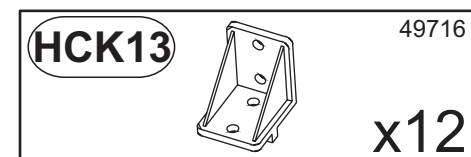
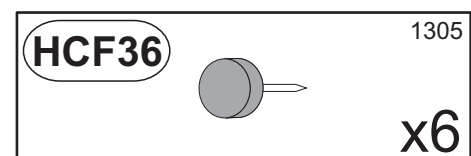
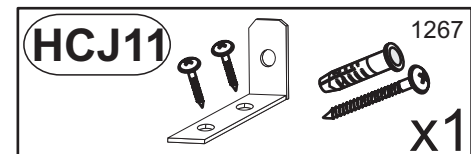
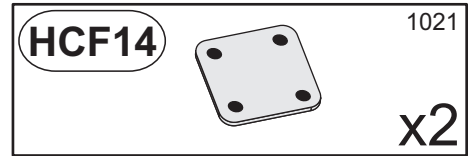
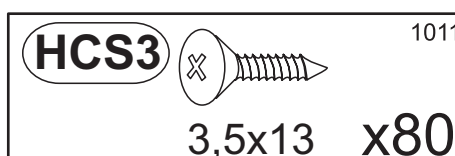
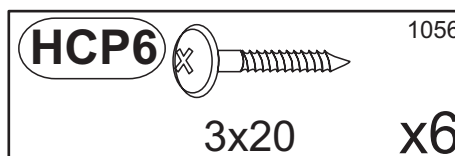
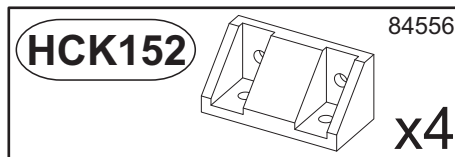
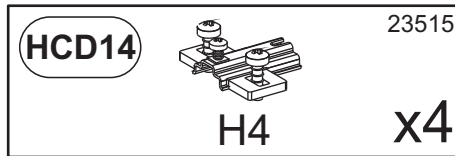
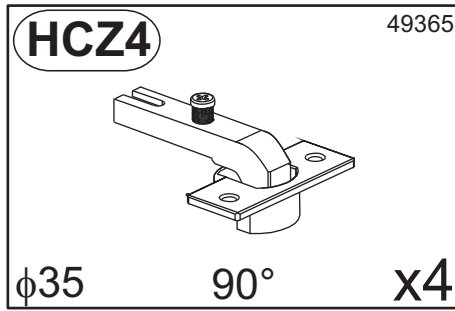
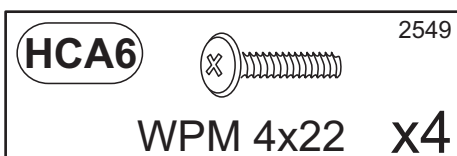
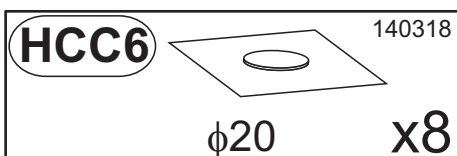
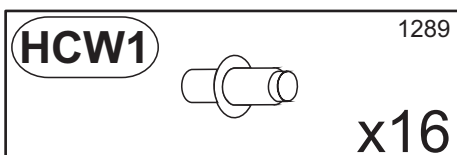
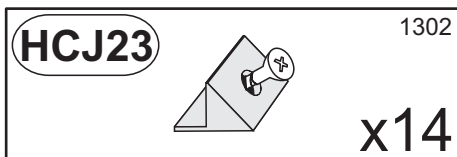
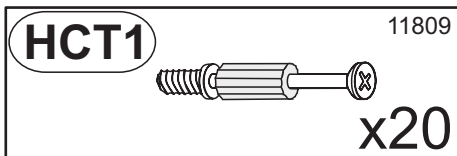
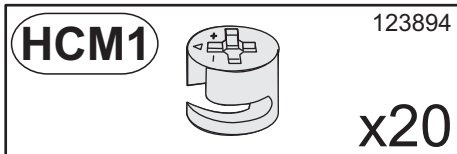
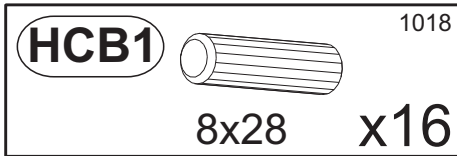
FLORENZ BAD 12

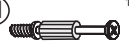

1

HCB1		1018
	8x28	x8
HCM1		123894
		x4
HCT1		11809
		x8

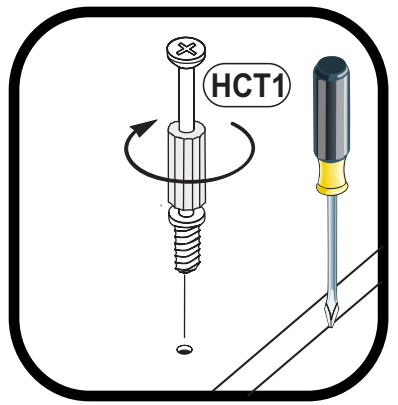
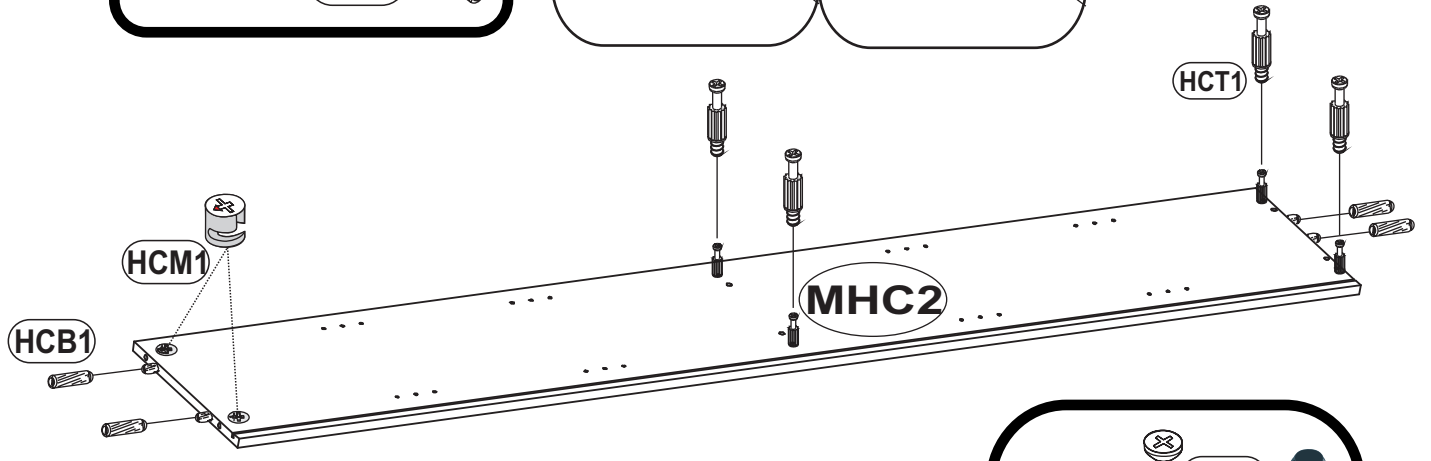
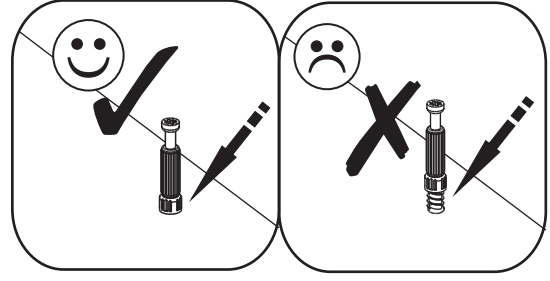
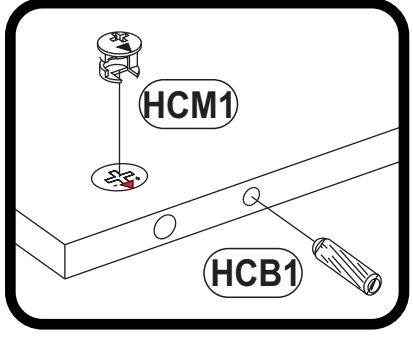
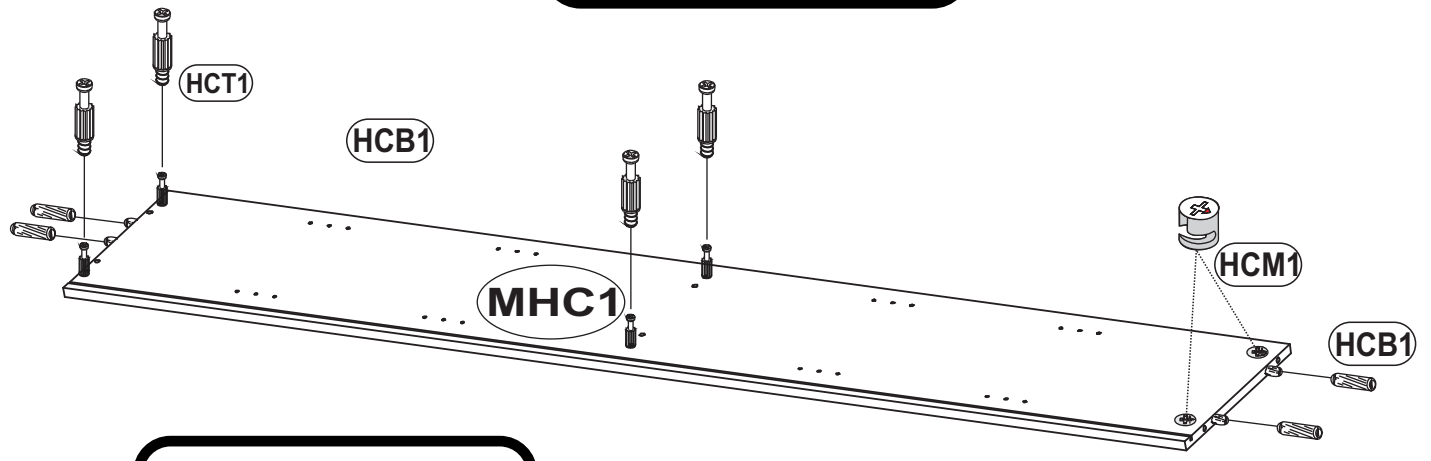
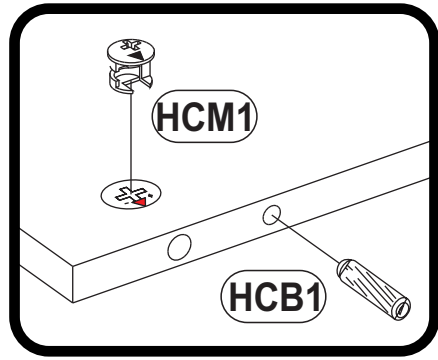
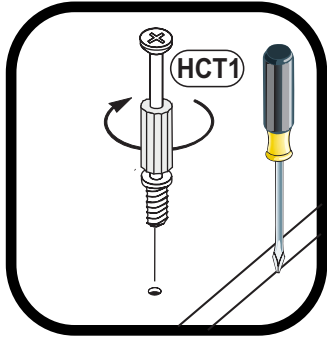

2

Option L

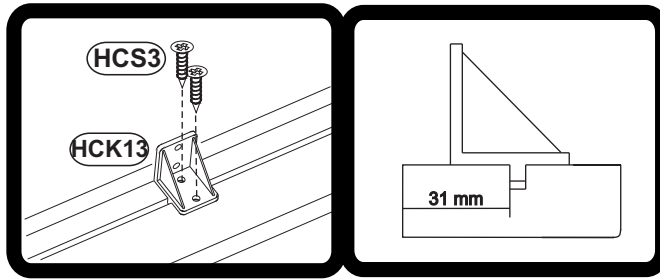
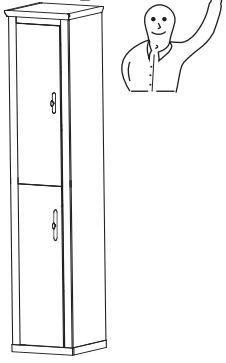

HCS3		1011
	3,5x13	x24
HCD14		23515
	H4	x4
HCK13		49716
		x12

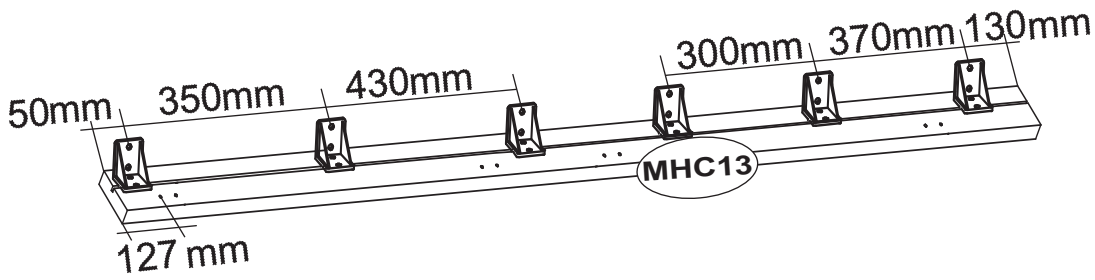
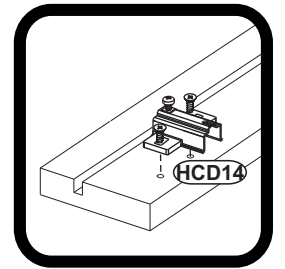
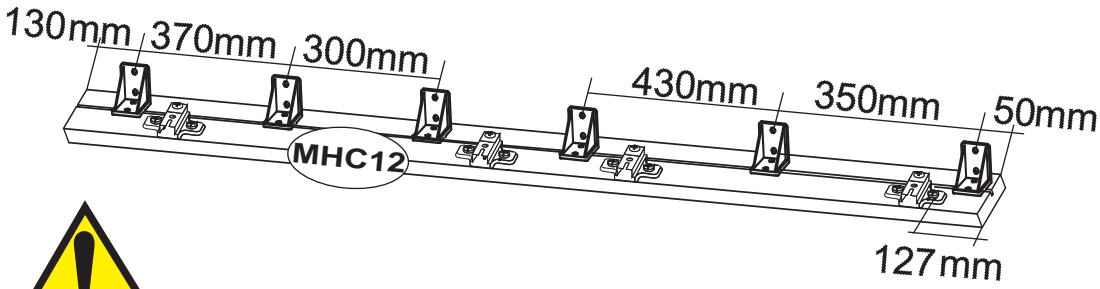

Option R

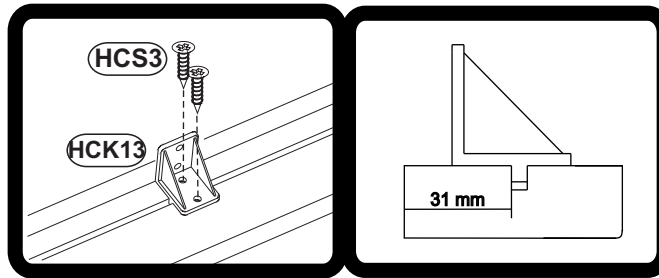
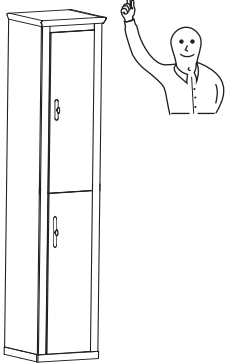



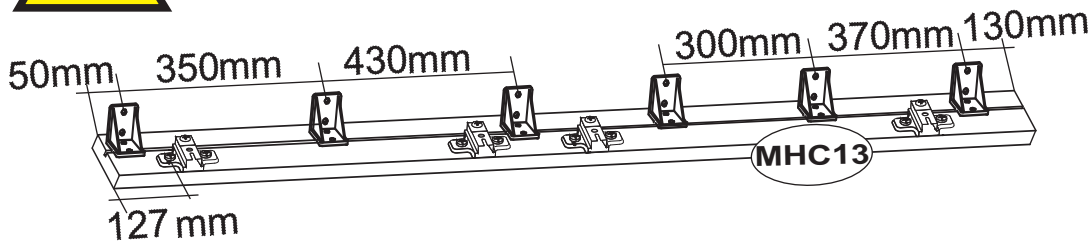
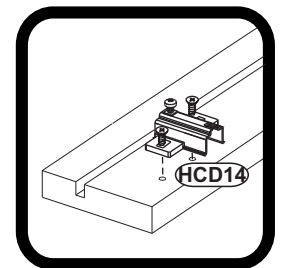
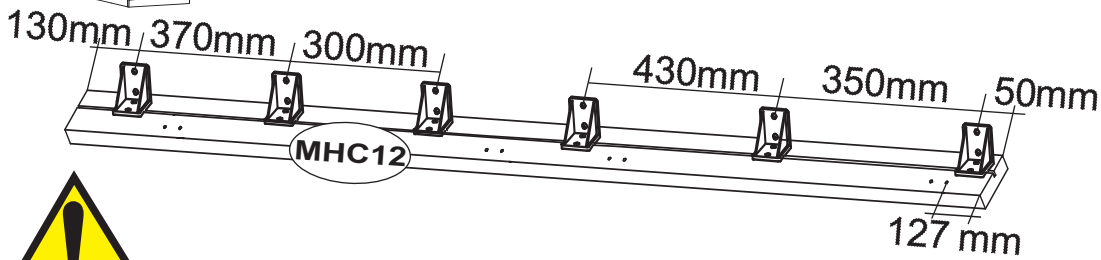

HCS3		1011
	3,5x13	x24
HCD14		23515
	H4	x4
HCK13		49716
		x12

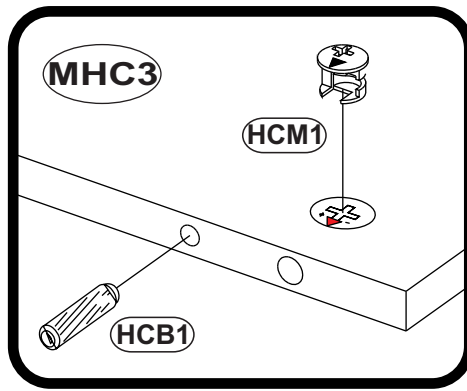

3



HCB1		1018
	8x28	x8
HCM1		123894
		x8
HCF14		1021
		x2
HCS3		1011
	3,5x13	x4

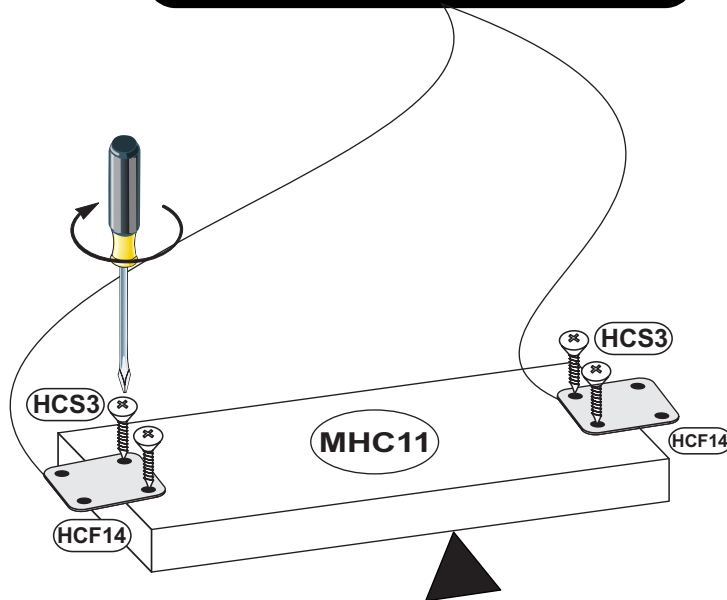
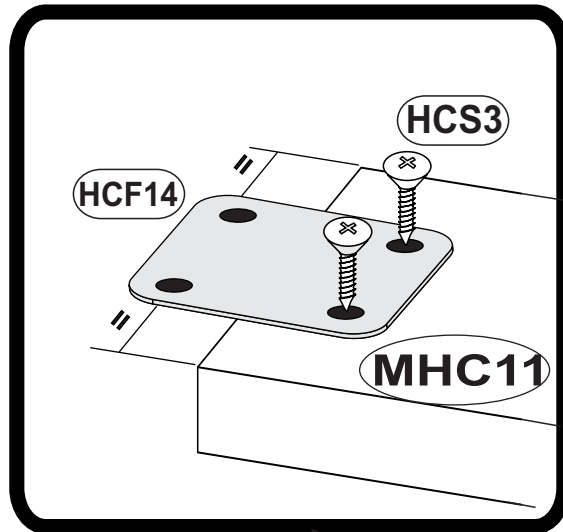
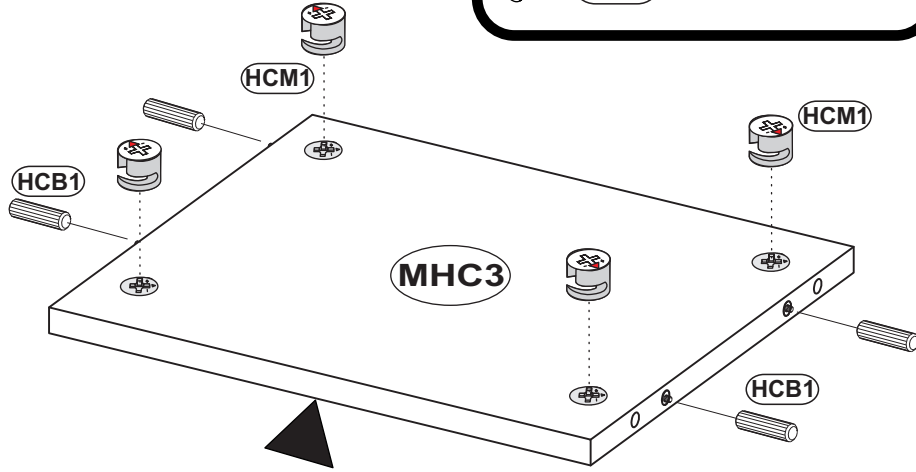

4

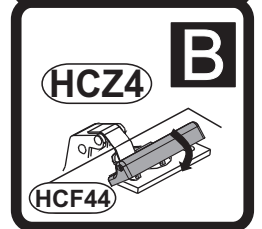
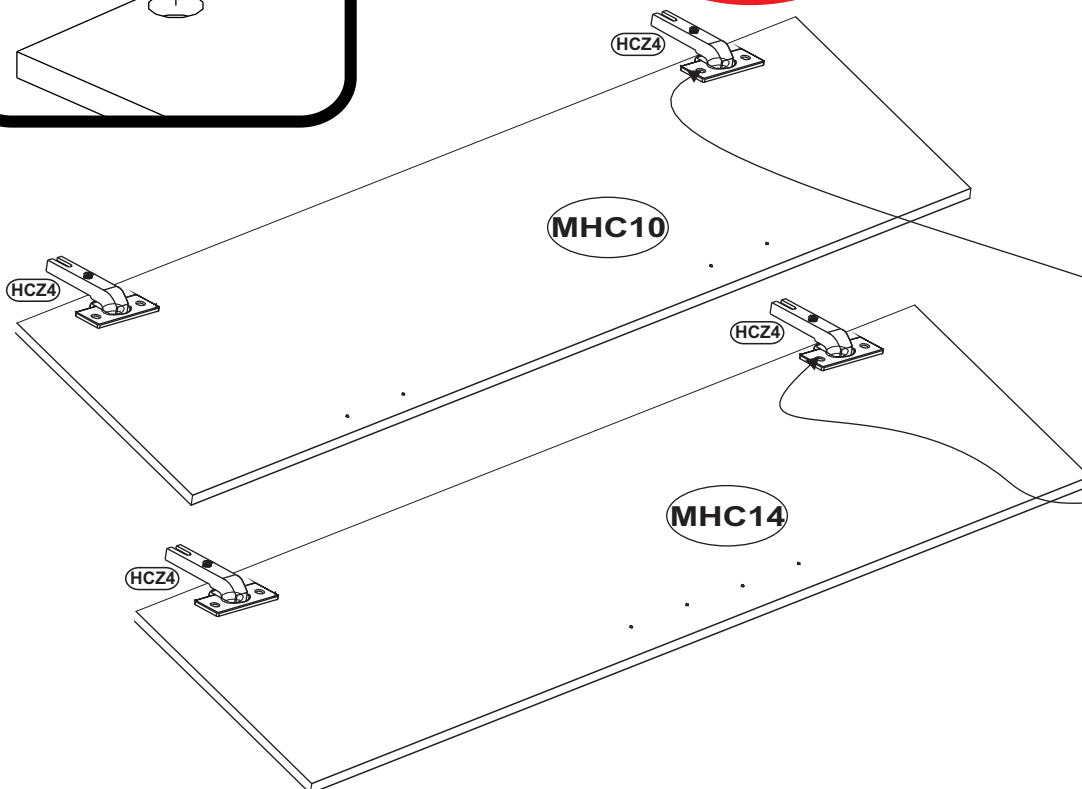
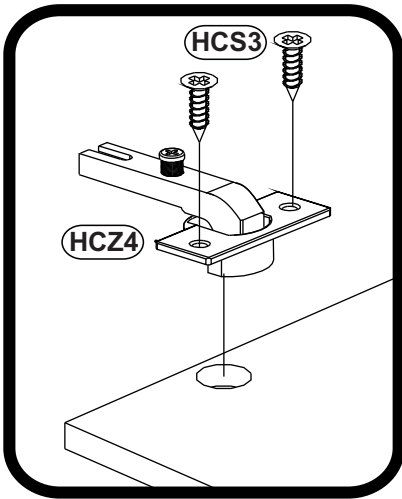
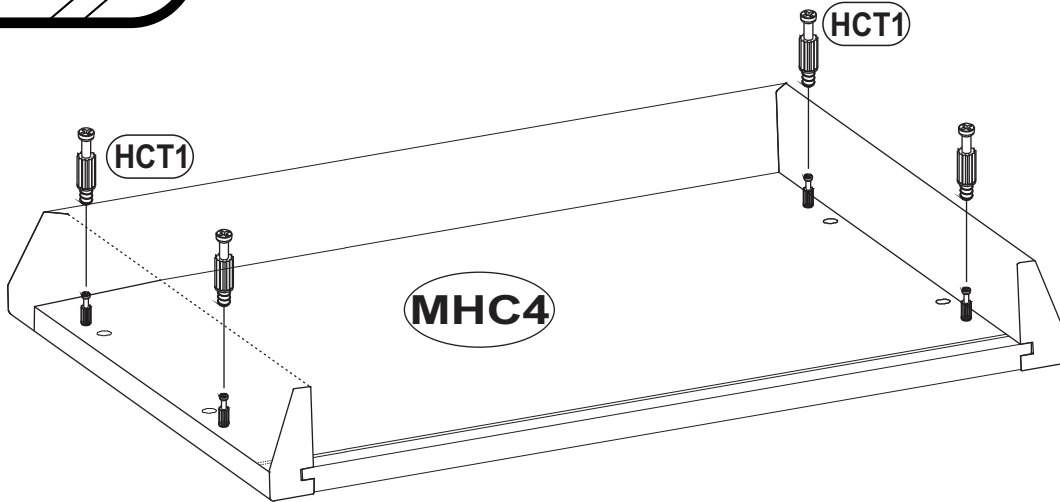
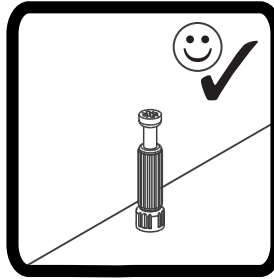
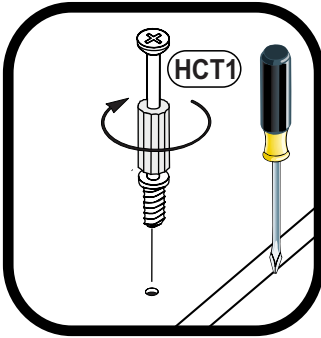
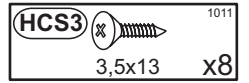
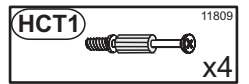
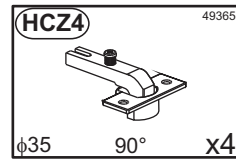

5

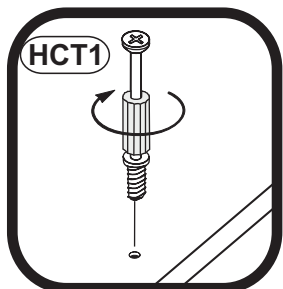
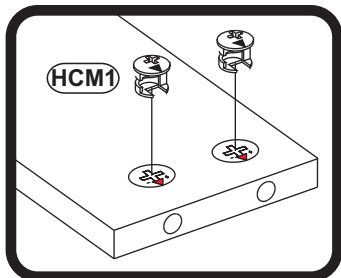
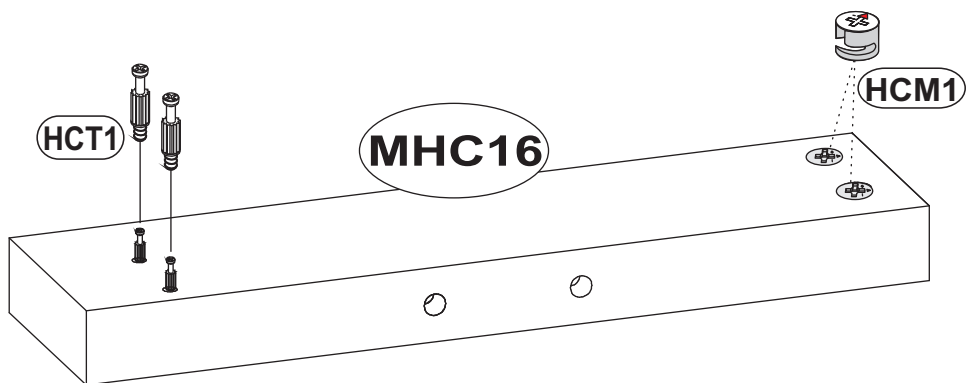
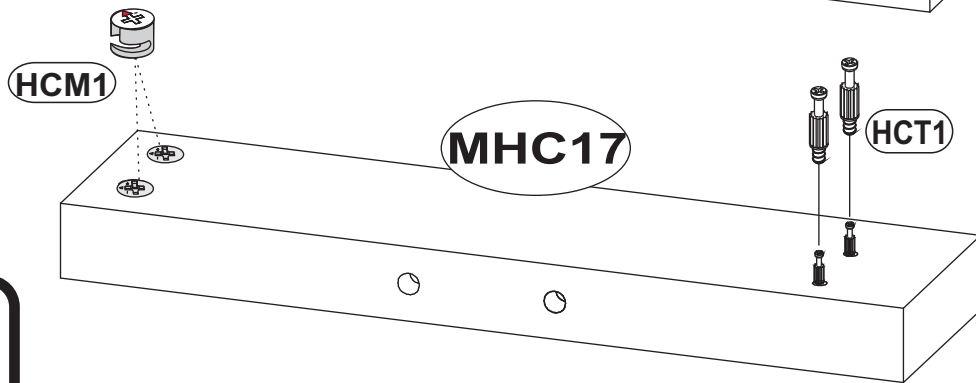
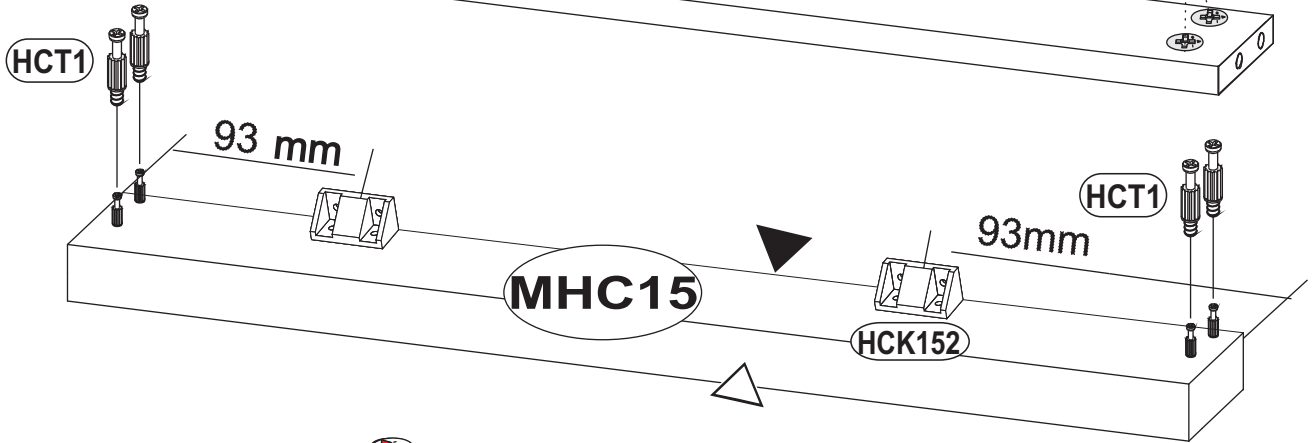
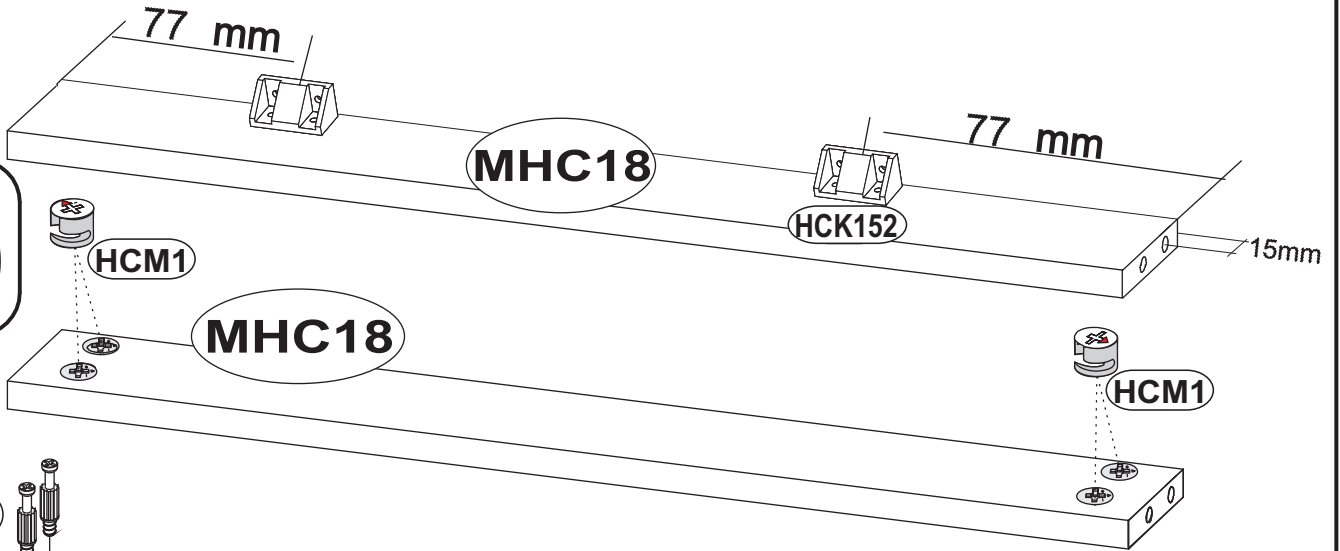
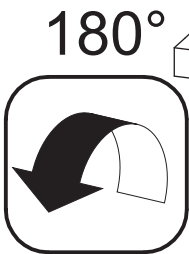
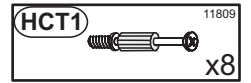
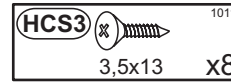
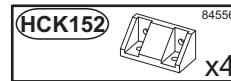
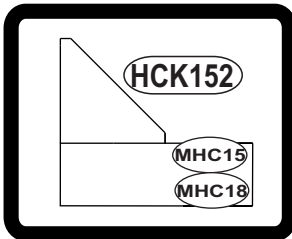
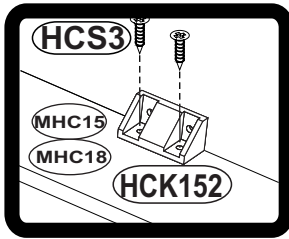



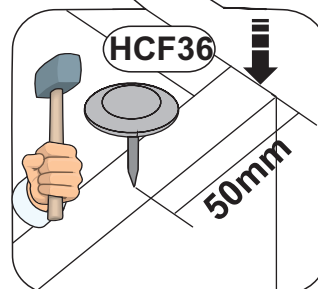
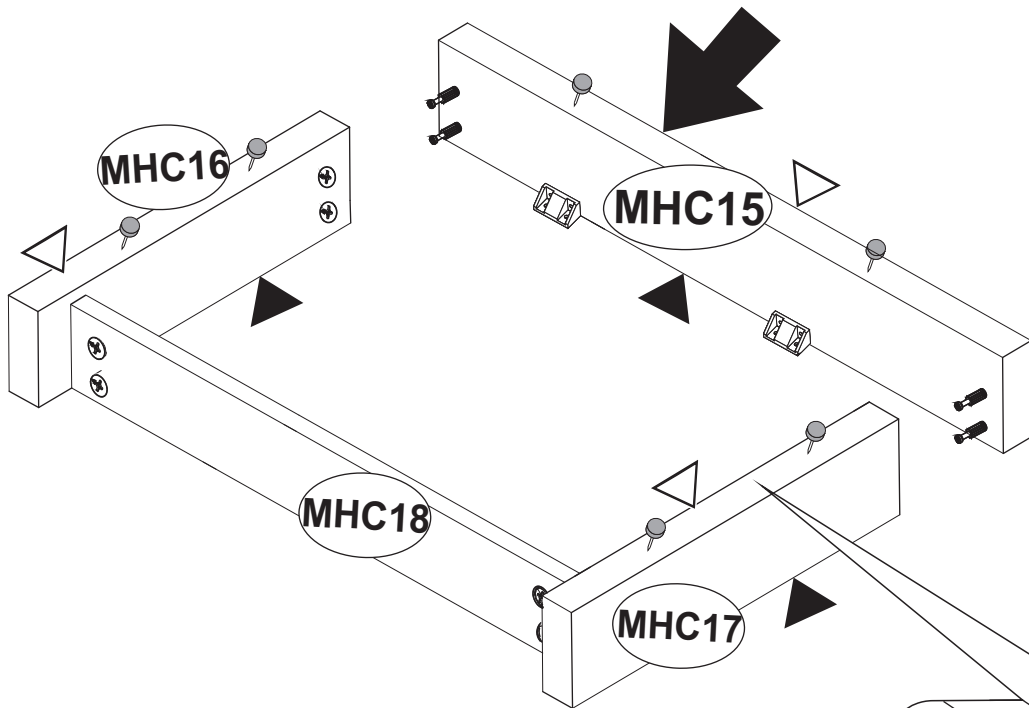
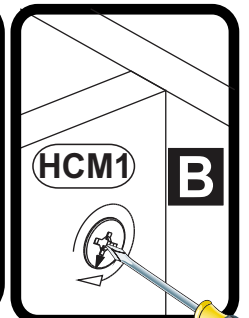
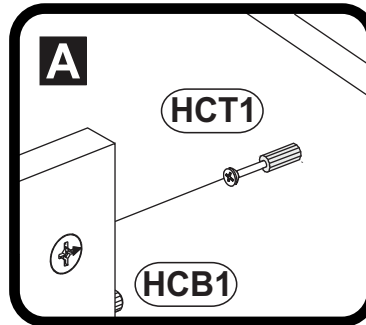
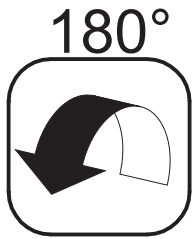
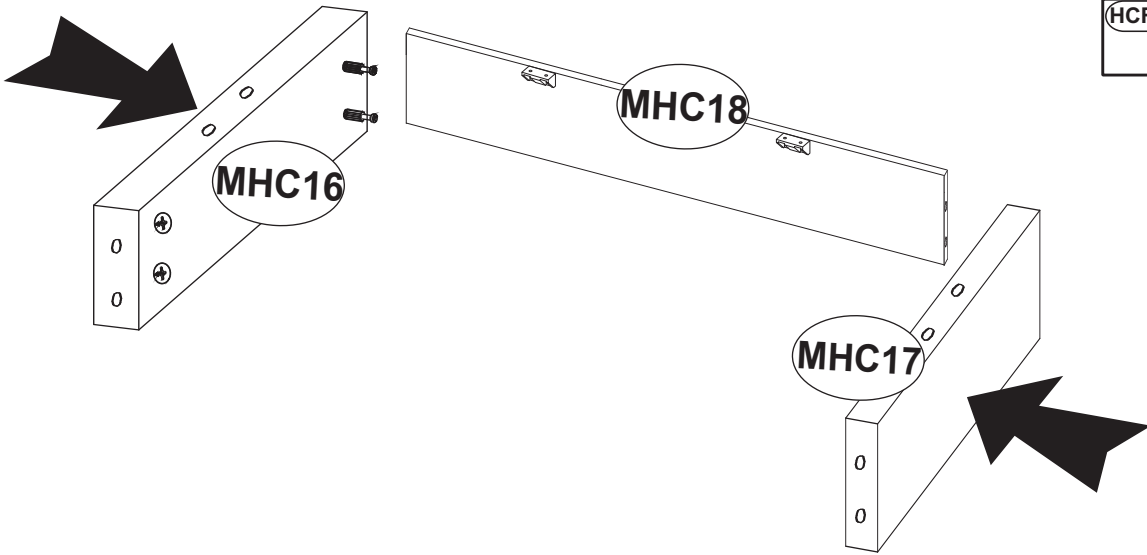

6

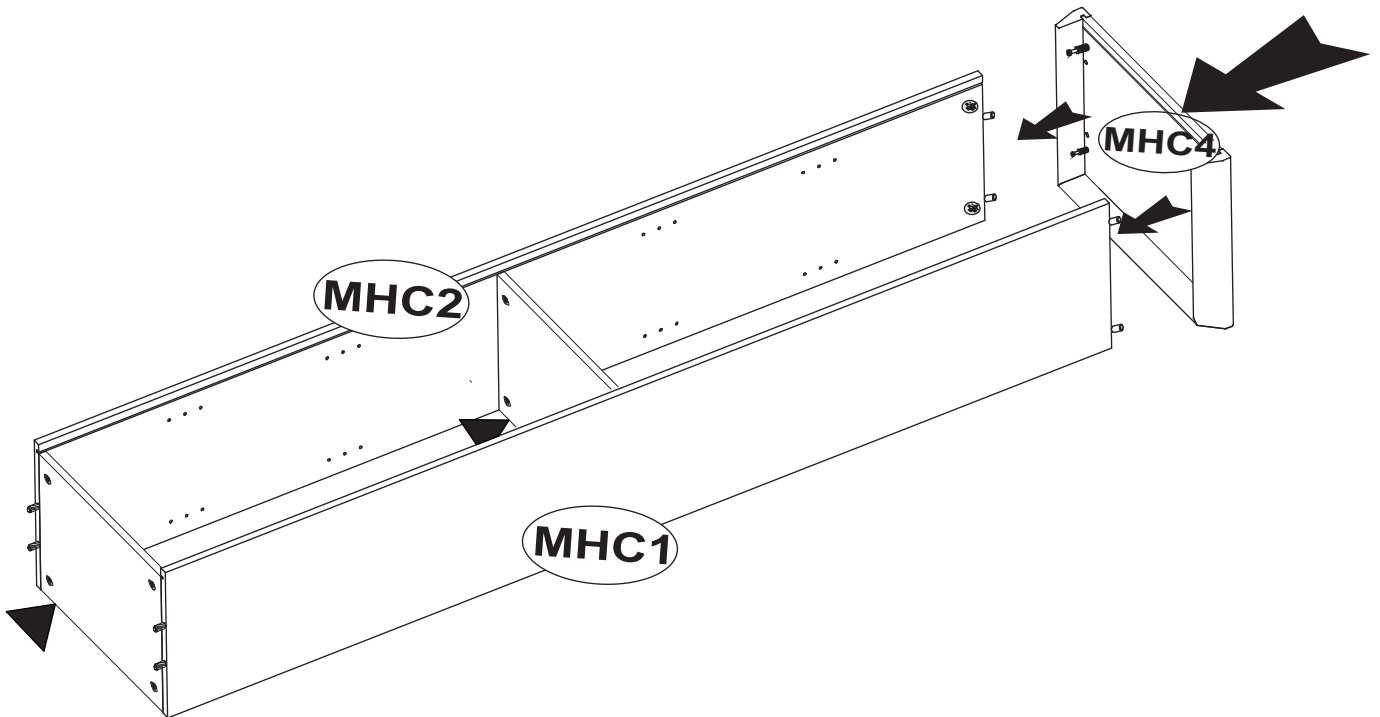
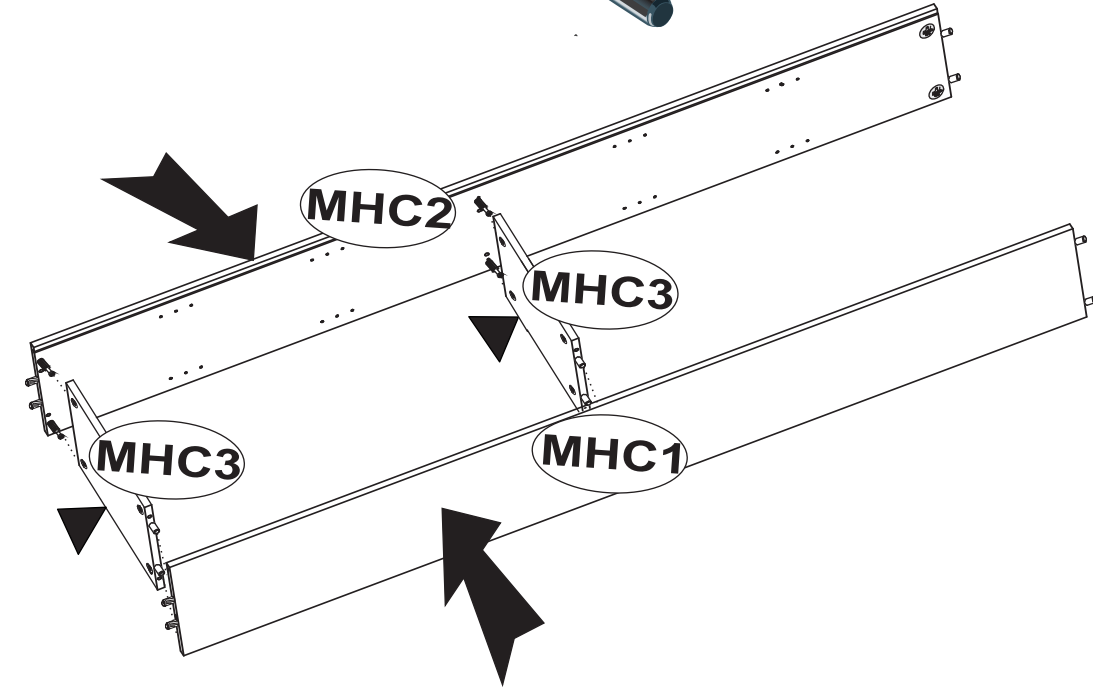
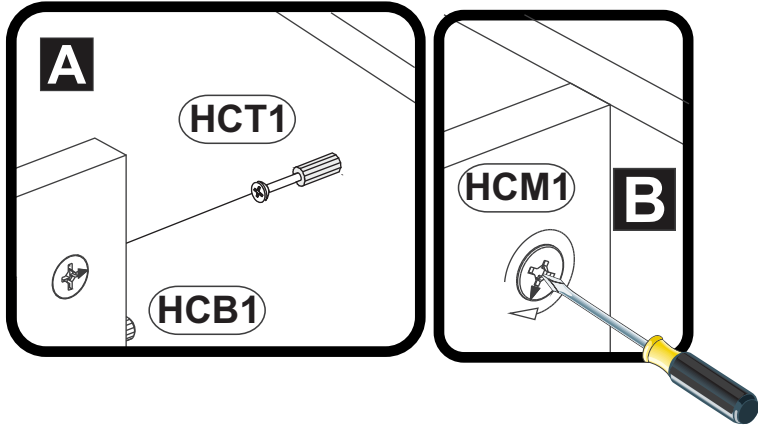
HCF36 1305
4x30 x6





HCS3 	1011
3,5x13	x8
HCP6 	1056
3x20	x6
HCJ23 	1302
	x14
HCF1 	1415
	x3

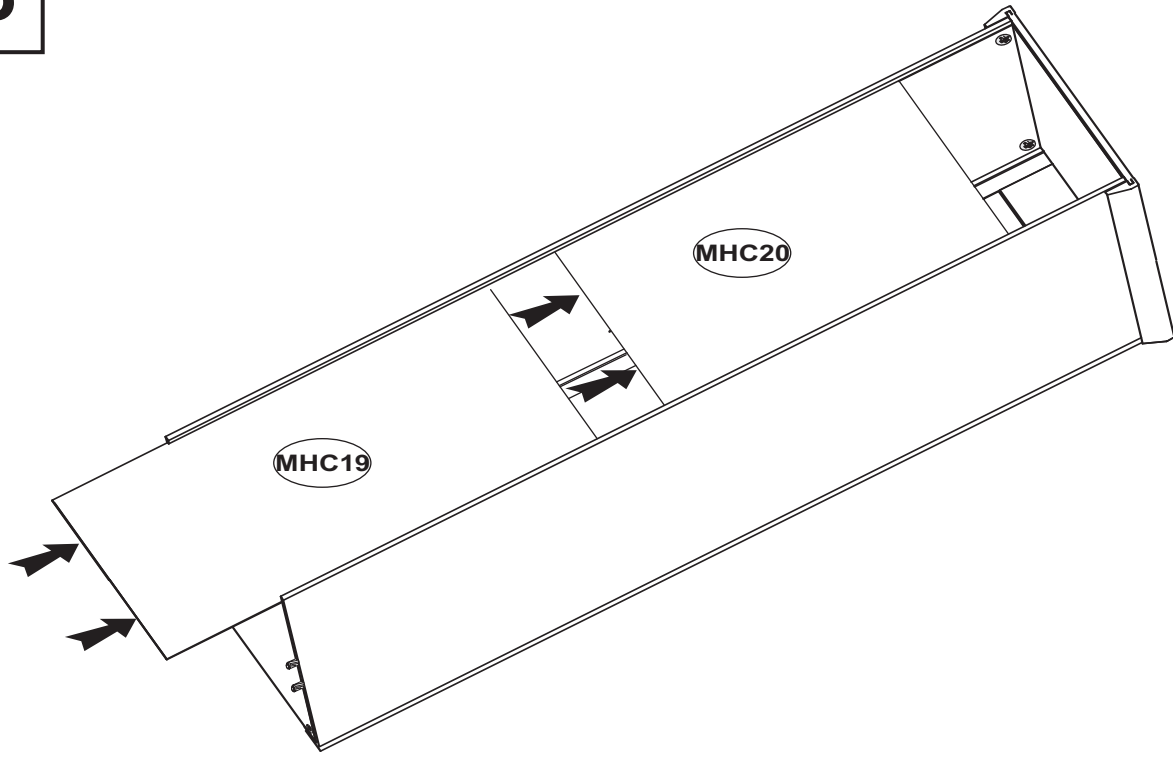

A

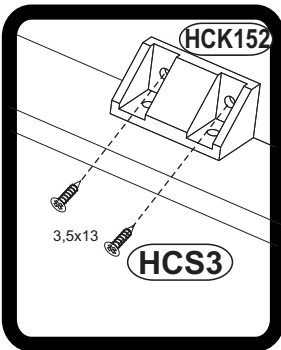

B

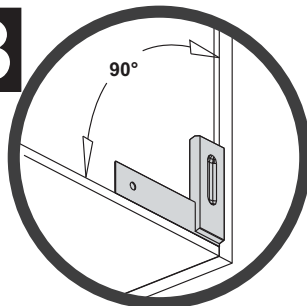

C

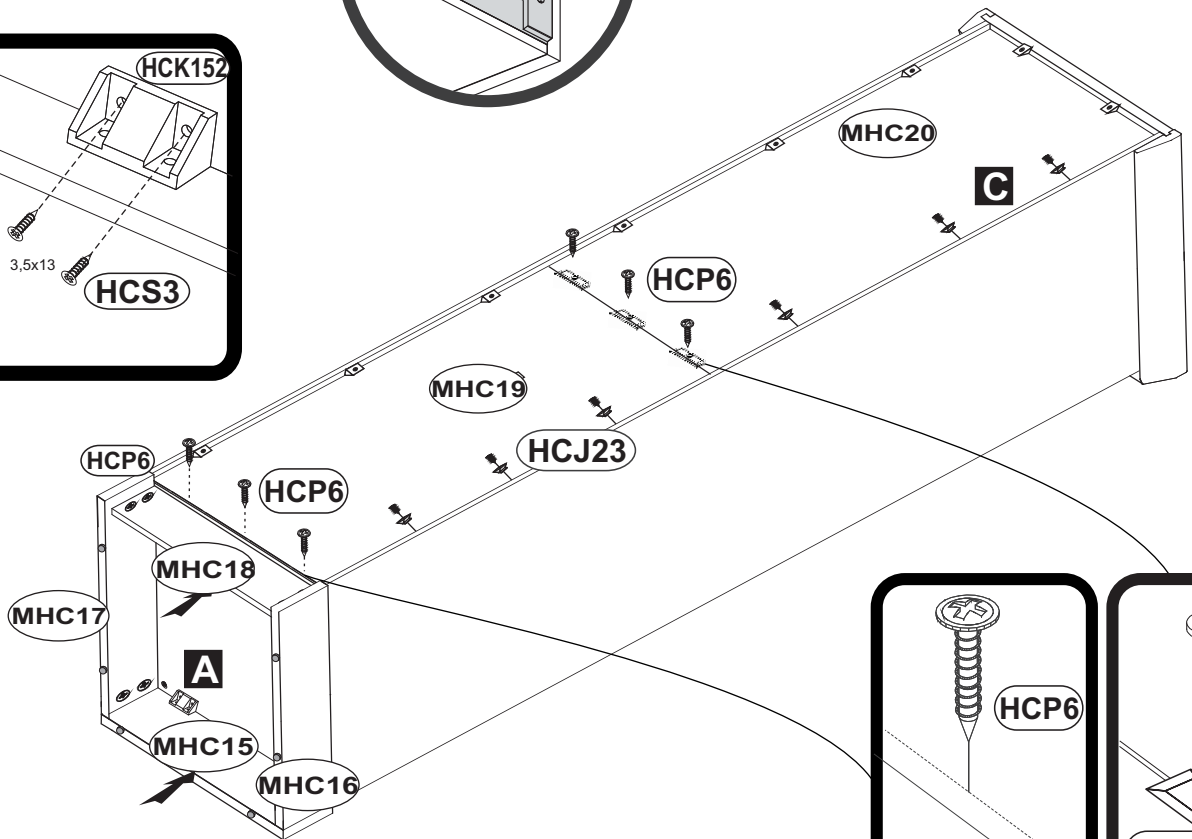
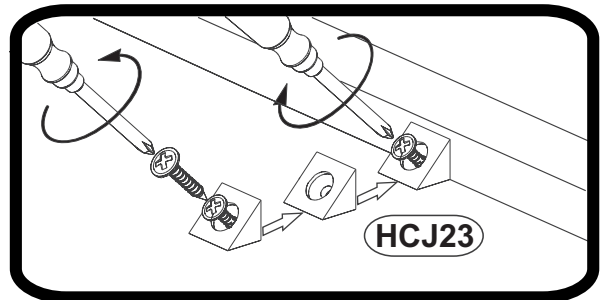

D

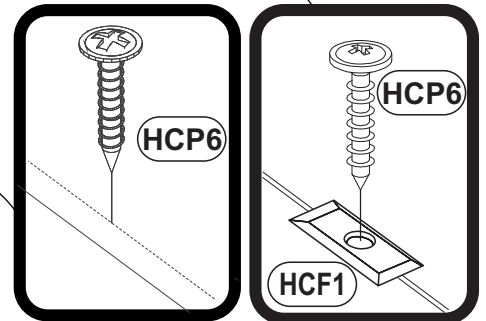

9A

Option L

HCS3 1011
3,5x13 x28

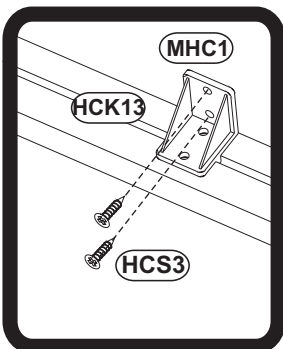
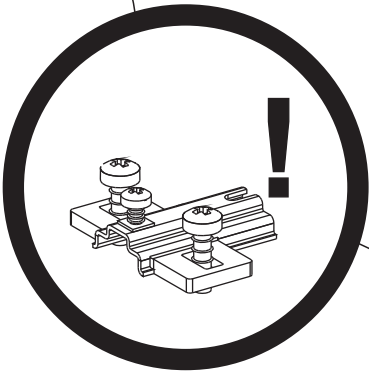
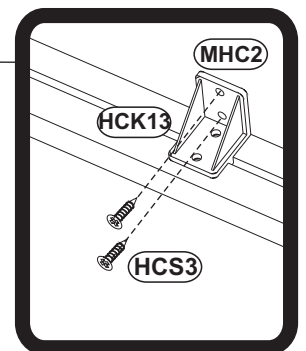
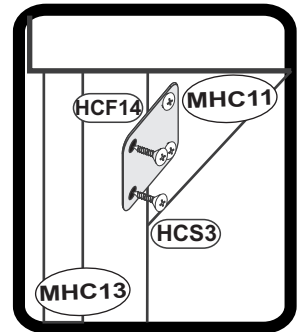
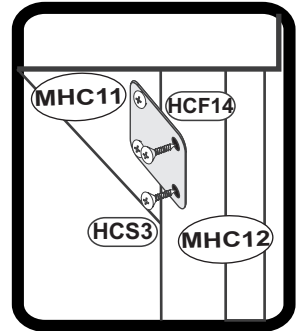
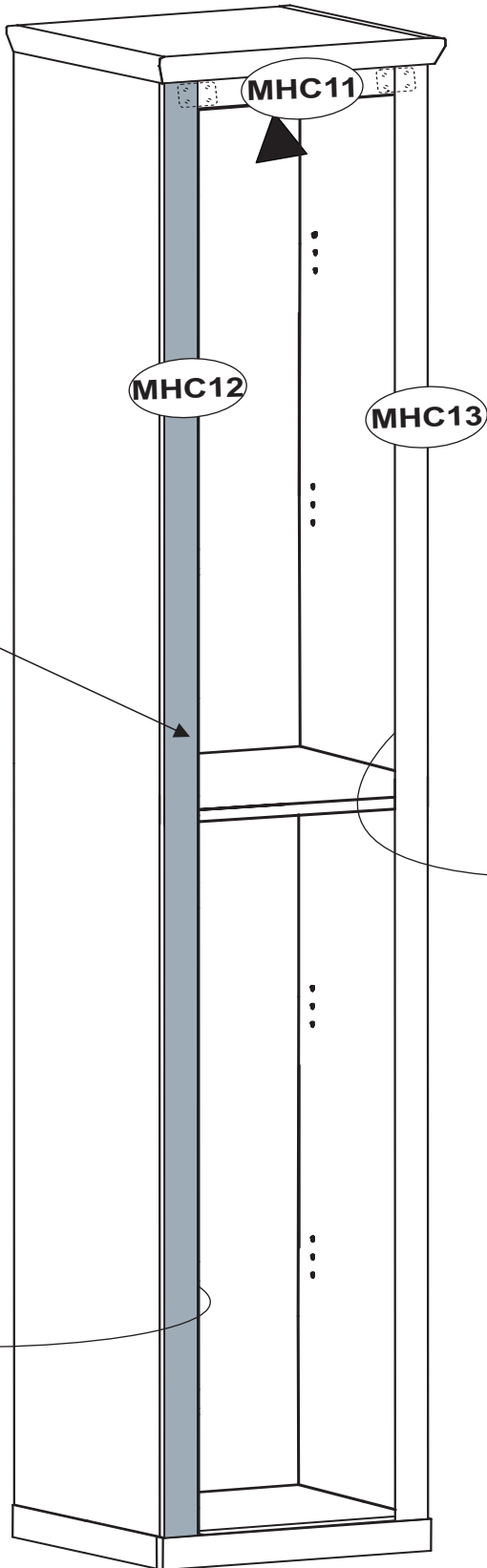
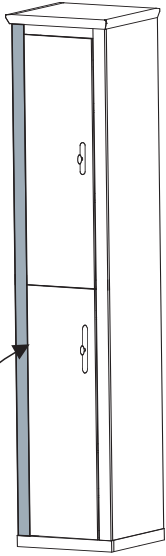
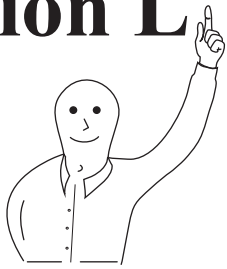

9B

HCS3 1011
3,5x13 x28



Option R

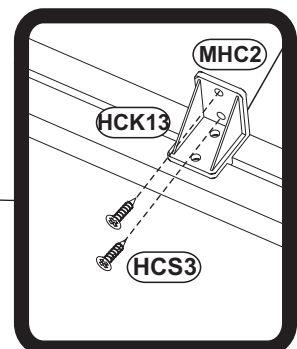
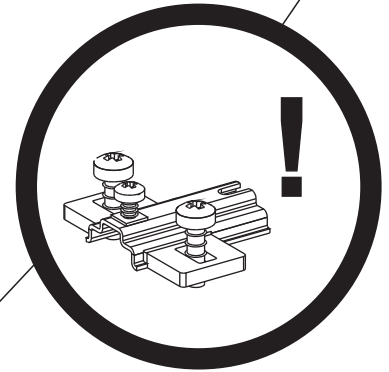
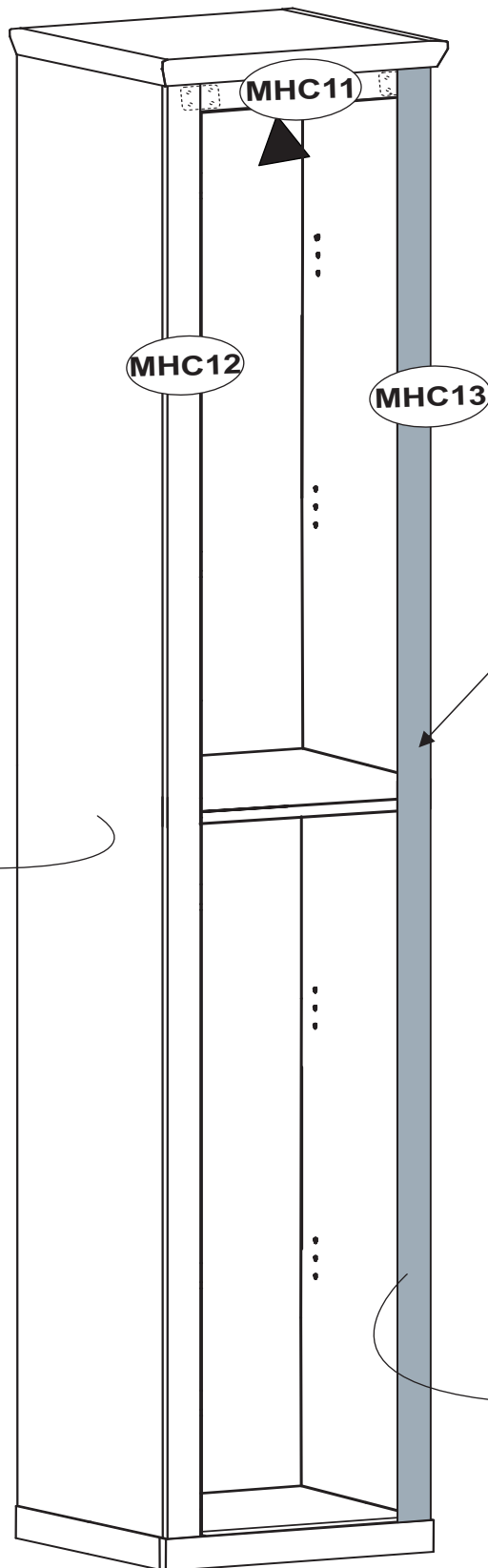
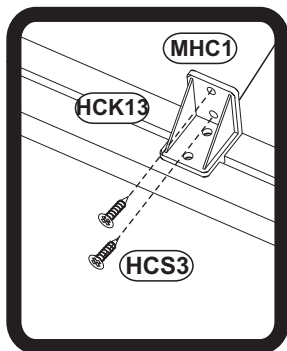
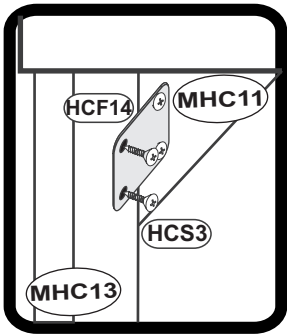
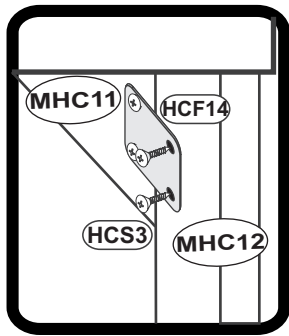
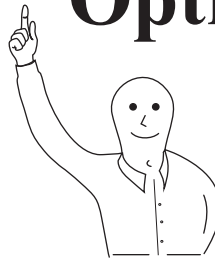

10

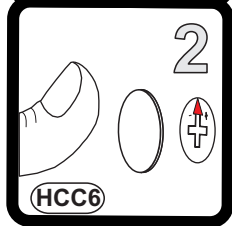
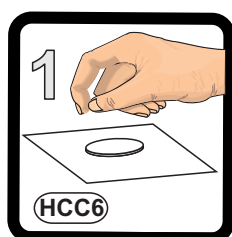
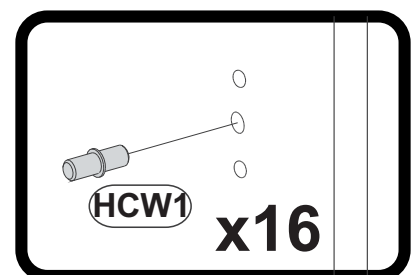
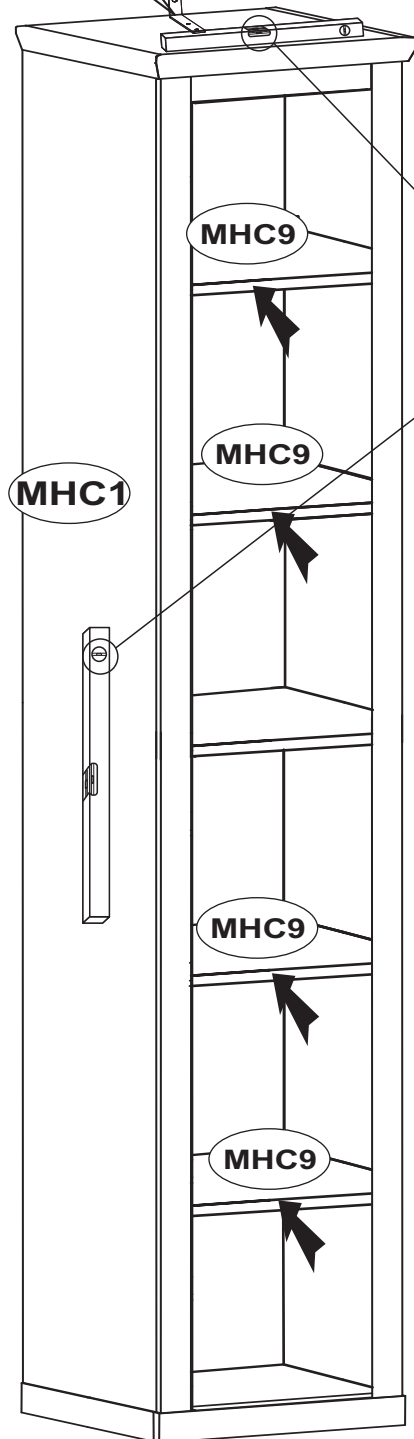
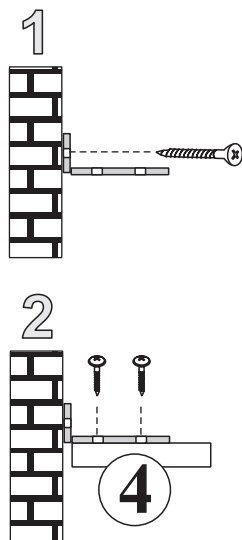
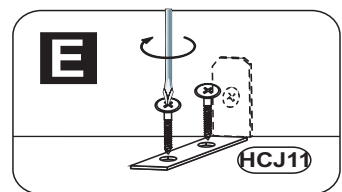
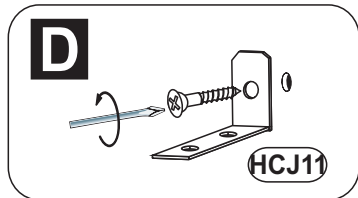
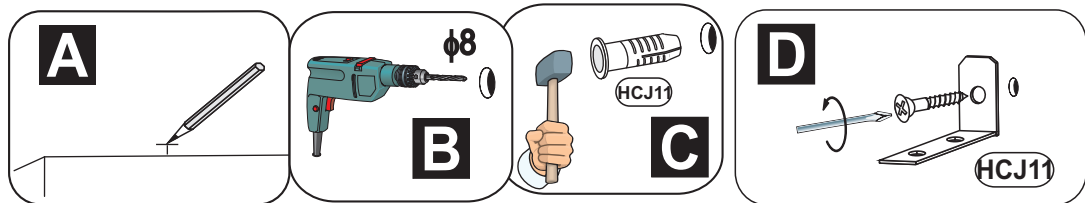
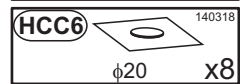
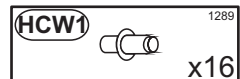
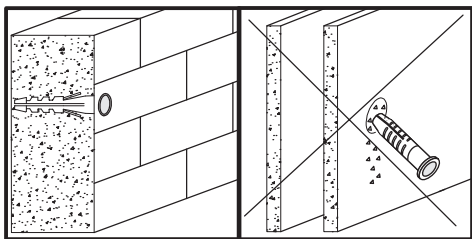

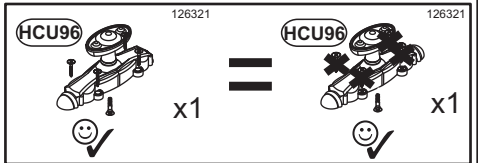
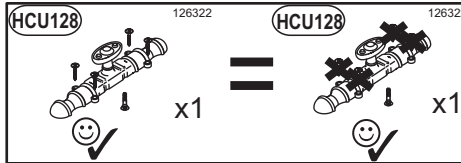
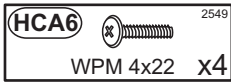

Option L



Option R

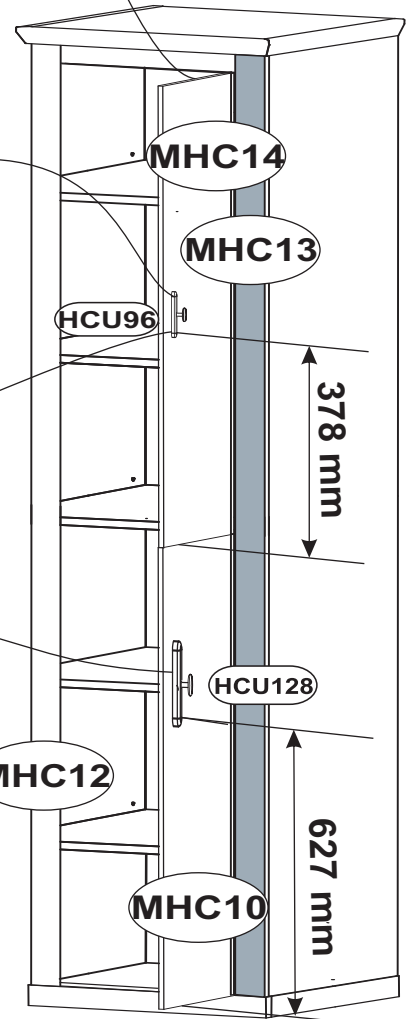
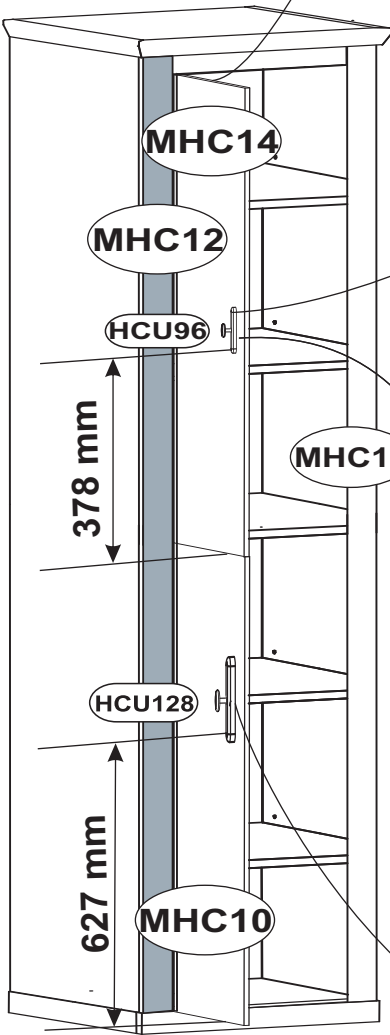
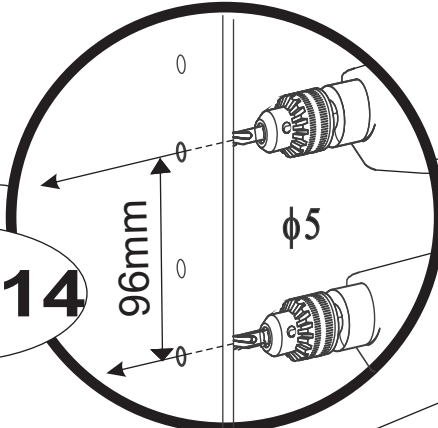
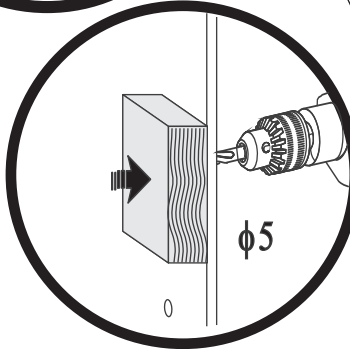
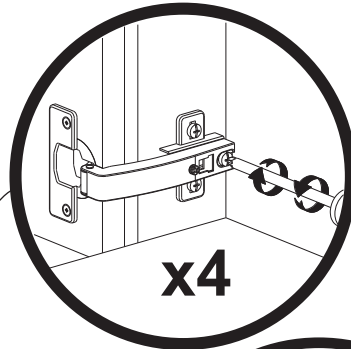
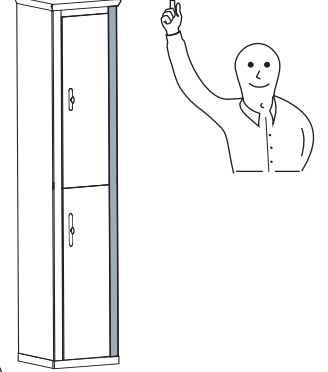

MHC14

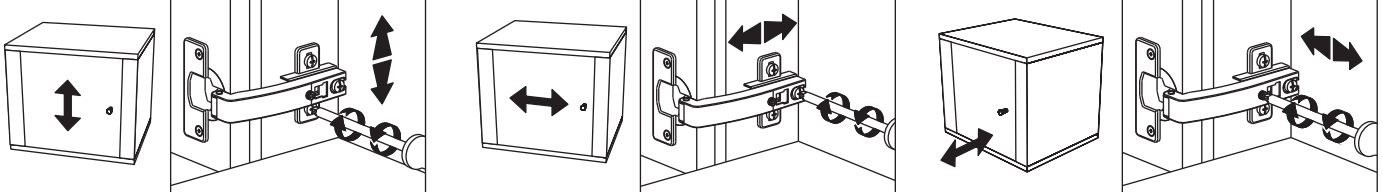
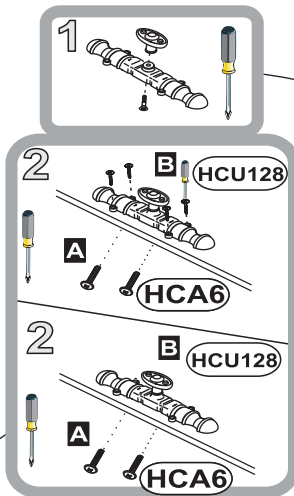
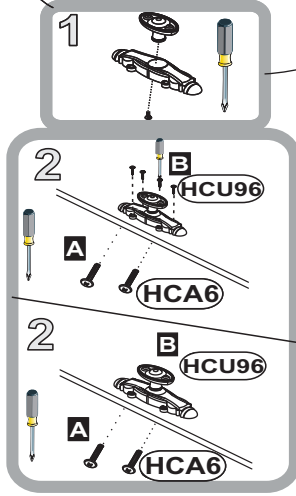

FLORENZ BAD 12



Option L

Option R

Unser Direktservice für Beschlagteile

D Sollte Ihnen ein Beschlagteil fehlen, können Sie diese Servicekarte direkt an die untenstehende Adresse mailen. Wir können allerdings nur Beschlagteile auf diesem Wege verschicken. Sollten Sie eine andere Beanstandung an Ihrem Möbelstück haben, so wenden Sie sich bitte direkt an Ihr Möbelhaus.

Our direct order service for fitting

GB If a fitting part is missing, you can e-mail this service card directly to the address below. However, we can only send fitting parts in this way. If you have any other cause for complaint concerning your item of furniture, please contact your furniture store directly.

Naše přímé služby pro kování

CZ Chybí-li vám nějaký díl z kování, můžete tuto servisní kartu odeslat e-mailem přímo na níže uvedenou adresu. Touto cestou však můžeme rozesílat jen díly kování. Pokud byste reklamovali jiný díl nábytku, obraťte se přímo na svého prodejce nábytku.

Bien étudier la notice de montage

F S'il vous manque une ferrure, veuillez envoyer directement la présente carte service à l'adresse e-mail indiquée ci-dessous. Cependant, ceci nous permet uniquement d'envoyer des ferrures. Pour tout autre type de réclamation concernant votre meuble, veuillez contacter directement votre magasin d'ameublement.

Il nostro servizio diretto per l'ordine della ferramenta

I Qualora Vi dovesse mancare un pezzo di fissaggio, allora Vi preghiamo di inviare questa carta di servizio immediatamente all'indirizzo sottostante. Possiamo inviare i pezzi di fissaggio solamente per mezzo di questo procedimento. Qualora dovete avere qualche altra reclamazione in merito al mobile, allora Vi preghiamo di rivolgerVi direttamente al Vostro Negozio di mobili.

Нашата директна услуга за обков

BG Ако липсват части от комплекта, попълнете настоящата сервисна карта и ни я изпратете на e-mail адреса, посочен по-долу. По този начин можем да доставяме само липсващи елементи от обкова. Ако установите други дефекти по мебелите, Ви съветваме да се обрнете към мебелната къща/магазин, от който сте закупили стоката.

Onze directservice voor losse onderdelen

NL Wanneer er een onderdeel ontbreekt, kunt u deze servicekaart direct aan onderstaand e-mailadres sturen. Wij kunnen langs deze weg echter alleen beslagdelen versturen. Mocht u een ander probleem aan uw meubel hebben, verzoeken wij u contact op te nemen met uw meubeldealer.

Nasz bezpośredni serwis czeski montażowych

PL Jeżeli brakuje części koniecznych do montażu, prosimy o przesłanie nam niniejszej karty serwisowej na niżej podany adres e-mailowy. W ten sposób możemy przesyłać Państwu tylko brakujące części. W przypadku innych reklamacji dotyczących mebla, prosimy zgłosić się do salonu meblowego, w którym został dokonany zakup.

Servis za okove

HR U slučaju da nedostaje neki od dijelova molimo vas da na dolje navedenu mail adresu pošaljete ovaj servisni obrazac. Na ovaj način mogu se dostaviti samo okove. U slučaju da imate dodatne prigovore vezane uz komad namještaja molimo vas da se obratite izravno trgovini namještaja gdje je isti kupljen.

Direktszolgalatunk vasalattok esetén

HU Ha hiányzik egy vasalat, ezt a kártyát közvetlenül elküldheti az alább található címre. Azonban csak a vasalattokat tudunk így küldeni. Amennyiben másfajta reklamációt áll fenn bútorárbaját illetően, forduljon közvetlenül a bútorházhoz.

Náš priamy servis pro častí kovania

SK Ak by Vám chýbala nejaká časť kovania, môžete poslať túto servisnú kartu poslať e-mailom na nižšie uvedenú adresu. Diely kovania vieme poslať iba týmto spôsobom. Ak by ste mali inú reklamáciu ohľadom Vašho nábytku, obraťte sa priamo na Vašu predajňu nábytku.

Naše direktne služne storitve za okovje

SLO Če vam manjka kakšno okovje, lahko to servisno kartico pošljete po e-pošti direktno na spodnji naslov. Po tej poti vam lahko pošljemo samo okovje. Če želite reklamirati kakšen drug del pohištva, se obrnite neposredno na vašo trgovino pohištva.

Service-ul nostru direct pentru feronerie

RO În cazul în care vă lipsește o piesă de feronerie puteți să trimiteți direct acest card de service prin e-mail la adresa de mai jos. Noi nu putem expedia piese de feronerie decât pe această cale. Dacă aveți o altă reclamație referitoare la piesa de mobilier, atunci vă rugăm să vă adresați direct la magazinul dvs. de mobilier.

Наш прямой сервис для поставок фурнитуры

RUS Если окажется, что Вам не хватает того или иного элемента фурнитуры, Вы можете отправить сервисную карту по факсу непосредственно на нижеприведенный адрес электронной почты. Однако, таким образом мы можем пересылать лишь фурнитуру. Если же у Вас возникнут иные претензии относительно приобретенной мебели, пожалуйста, обращайтесь непосредственно в организацию, осуществляющую продажу.

Vår direktservice för beslagsdelar

S Om du saknar en beslagsdel kan du skicka detta servicekort direkt till e-postadressen som anges nedan. Tänk på att detta är den enda möjligheten att skicka beslagsdelar till dig. Om du vill reklamera din möbel av en annan anledning måste du kontakta ditt möbelhus direkt.

Nuestro servicio directo para accesorios

ES Si le falta algún accesorio, puede enviar esta tarjeta de servicio directamente a la siguiente dirección. No obstante, por este medio solo podemos enviar accesorios. Si tiene alguna otra objeción sobre su mueble, consulte directamente con su mueblería.

Donatilar için doğrudan servisimiz

TR Bir donatınız eksikse bu servis kartını doğrudan aşağıda bulunan adrese doğrudan mail yazabilirsiniz. Sadece bu yolla donatılar gönderilebilir. Mobilyanızda başka şikayetleriniz varsa lütfen doğrudan mobilya satıcınıza danışın.

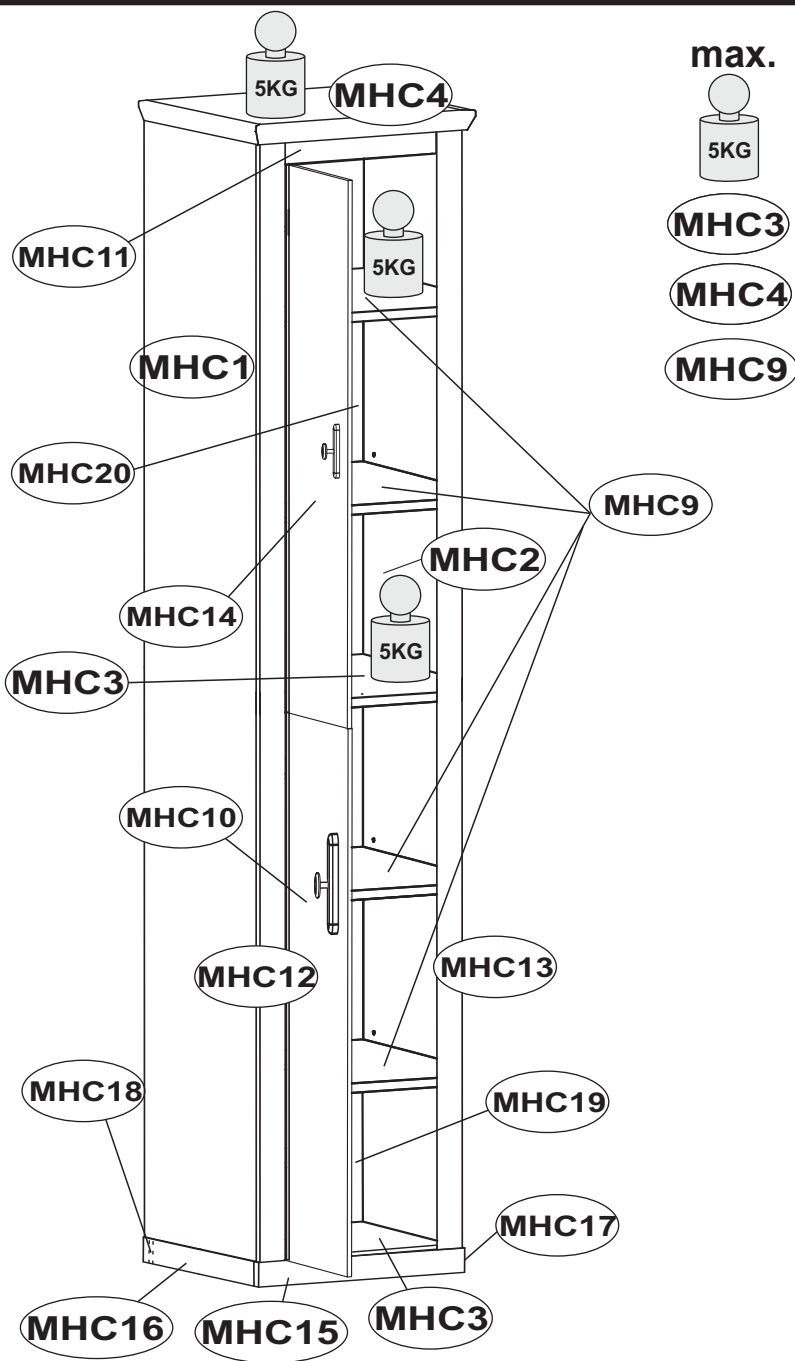

max.



MHC3

MHC4

MHC9

MHC1	1905	298	15	2/2
MHC2	1905	298	15	2/2
MHC3	329	277	15	1/2
MHC4	450	350	65	1/2
MHC9	328	267	15	1/2
MHC10	888	225	15	2/2
MHC11	231	120	18	1/2
MHC12	1905	65	22	2/2

MHC13	1905	65	22	2/2
MHC14	888	225	15	2/2
MHC15	373	80	32	1/2
MHC16	291	80	32	1/2
MHC17	291	80	32	1/2
MHC18	308	70	15	1/2
MHC19	892	341	3	2/2
MHC20	1019	341	3	2/2

FLORENZ BAD 12

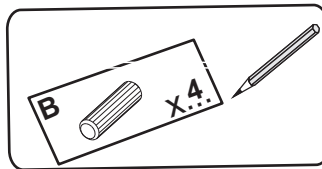
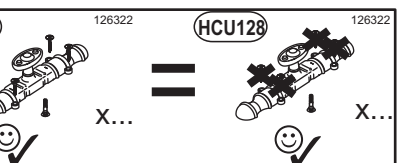
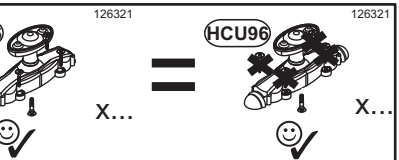
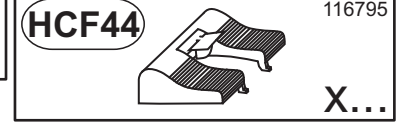
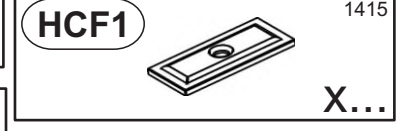
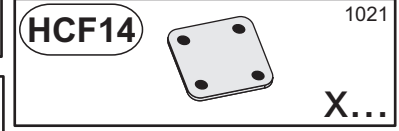
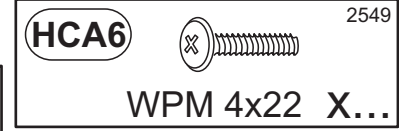
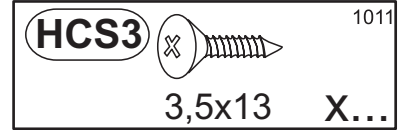
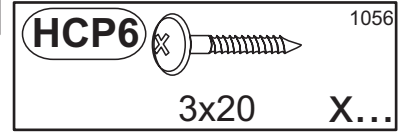
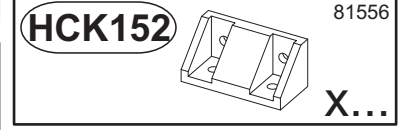
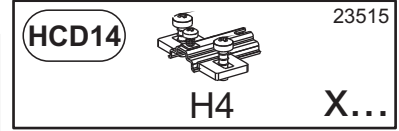
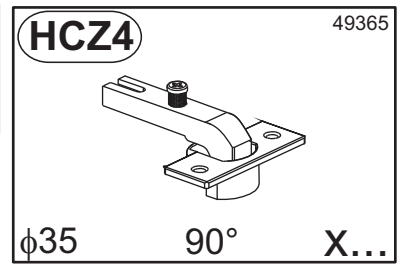
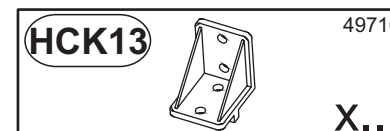
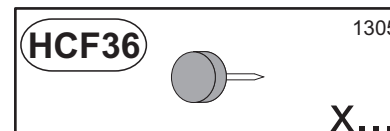
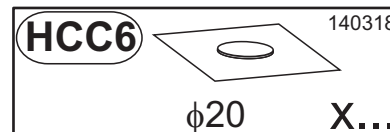
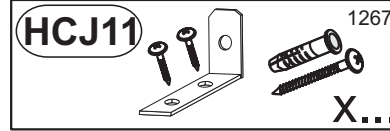
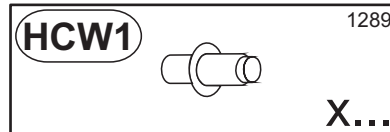
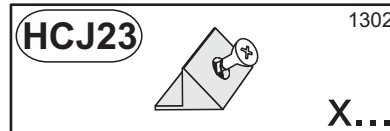
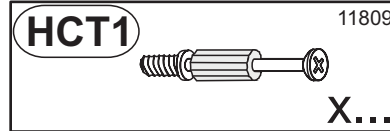
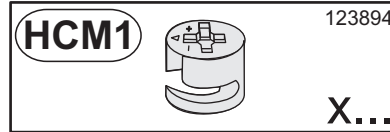
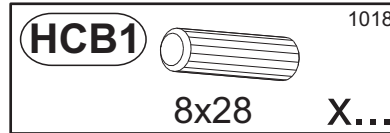

D Unser Direktservice für Beschlagteile
Sollte Ihnen ein Beschlagteil fehlen, können Sie diese Servicekarte direkt an die untenstehende Adresse mailen. Wir können allerdings nur Beschlagteile auf diesem Wege verschicken. Sollten Sie eine andere Beanstandung an Ihrem Möbelstück haben, so wenden sie sich bitte direkt an Ihr Möbelhaus.

GB Our direct order service for fitting
If a fitting part is missing, you can e-mail this service card directly to the address below. However, we can only send fitting parts in this way. If you have any other cause for complaint concerning your item of furniture, please contact your furniture store directly.

CZ Naše přímé služby pro kování
Chybí-li vám nějaký díl z kování, můžete tuto servisní kartu odeslat e-mailem přímo na níže uvedenou adresu. Touto cestou však můžeme rozesílat jen díly kování. Pokud byste reklamovali jiný díl nábytku, obraťte se přímo na svého prodejce nábytku.

F Bien étudier la notice de montage
S'il vous manque une ferrure, veuillez envoyer directement la présente carte service l'adresse e-mail indiquée ci-dessous. Cependant, ceci nous permet uniquement d'envoyer des ferrures. Pour tout autre type de réclamation concernant votre meuble, veuillez contacter directement votre magasin d'ameublement.

I Il nostro servizio diretto per l'ordine della ferramenta
Qualora Vi dovesse mancare un pezzo di fissaggio, allora Vi preghiamo di inviare questa carta di servizio immediatamente all'indirizzo sottostante. Possiamo inviare i pezzi di fissaggio solamente per mezzo di questo procedimento. Qualora dovete avere qualche altra reclamazione in merito al mobile, allora Vi preghiamo di rivolgerVi direttamente al Vostro Negozio di mobili.

BG Нашата директна услуга за обкоя
Ако липсват части от комплекта, попълнете настоящата сервисна карта и ни я изпратете на e-mail адреса, посочен по-долу. По този начин можем да доставяме само липсващи елементи от обкоя. Ако установите други дефекти по мебелите, Ви съветваме да се обърнете към мебелната къща/магазин, от който сте закупили стоката.

NL Onze directservice voor losse onderdelen
Wanneer er een onderdeel ontbreekt, kunt u deze servicekaart direct aan onderstaand e-mailadres sturen. Wij kunnen alleen de weg echter alleen beslagdelen versturen. Mocht u een ander probleem aan uw meubel hebben, verzoeken wij u contact op te nemen met uw meubeldealer.

PL Nasz bezpośredni serwis części montażowych
Jeżeli brakuje części końcowych do montażu, prosimy o przesłanie nam niniejszej karty serwisowej na niżej podany adres e-mailowy. W ten sposób możemy przesać Państwu tylko brakujące części. W przypadku innych reklamacji dotyczących mebla, prosimy zgłosić się do salonu meblowego, w którym został dokonany zakup.

HR Servis za okove
U slučaju da nedostaje neki od dijelova molimo vas da na dolje navedenu mail adresu pošaljete ovaj servisni obrazac. Na ovaj način mogu se dostaviti samo okovi. U slučaju da imate dodatne prigovore vezane uz komad namještaja molimo vas da se obratite izravno trgovini namještaja gdje je isti kupljen.

HU Direktszolgáltatunk vasalatok esetén
Ha hiányzik egy vasalattól, ezt a kártyát közvetlenül elküldheti az alább található címre. Azonban csak vasalattokat tudunk így küldeni. Amennyiben másfajta reklamáció áll fenn bútordarabját illetően, forduljon közvetlenül a bútorháznál.

SK Naš priamy servis pre časti kovania
Ak by Vám chýbala nejaká časť kovania, môžete poslať túto servisnú kartu poslať e-mailom na nižšie uvedenú adresu. Dieľky kovania vieme poslať iba týmto spôsobom. Ak by ste mali inú reklamáciu ohľadom Vášho nábytku, obráťte sa priamo na Vašu predajňu nábytku.

SLO Naše direktne uslužne storitve za okovje
Če vam manjka kakšno okovje, lahko to servisno kartico pošljete po e-pošti direktno na spodnji naslov. Po tej poti vam lahko pošljemo samo okovje. Če želite reklamirati kakšen drug del pohištva, se obrnite neposredno na vašo trgovino pohištva.

RO Service-ul nostru direct pentru feronerie
In cazul in care va lipseste o piesa de feronerie puteti sa trimiteți direct acest card de service prin e-mail la adresa de mai jos. Noi nu putem expedia piese de feronerie decât pe această cale. Dacă aveți o altă reclamație referitoare la piesa de mobilier, atunci vă rugăm să vă adresați direct la magazinul dvs. de mobilă.

RUS Наш прямой сервис для поставок фурнитуры
Если окажется, что Вам не хватает того или иного элемента фурнитуры, Вы можете отправить сервисную карту по факсу непосредственно на нижеприведенный адрес электронной почты. Однако, таким образом мы можем пересылать лишь фурнитуру. Если же у Вас возникнут иные претензии относительно приобретенной мебели, пожалуйста, обращайтесь непосредственно в организацию, осуществившую продажу.

S Vir direktservice för beslagsdelar
Om du saknar en beslagsdel kan du skicka detta servicekort direkt till e-postadressen som anges nedan. Tänk på att detta är den enda möjligheten att skicka beslagsdelar till dig. Om du vill reklamera din möbel av en annan anledning måste du kontakta ditt möbelför direkt.

ES Nuestro servicio directo para accesorios
Si le falta algún accesorio, puede enviar esta tarjeta de servicio directamente a la siguiente dirección. No obstante, por este método solo podemos enviar accesorios. Si tiene alguna otra objeción sobre su mueble, consulte directamente con su mueblería.

TR Donatılar için doğrudan servisimiz
Bir donatınız eksikse bu servis kartını doğrudan aşağıda bulunan adrese doğrudan mail yazabilirsiniz. Sadece bu yölla donatıları gönderebilirsiniz. Mobilyanızda başka şikayetleriniz varsa lütfen doğrudan mobilya satıcınıza danışın.