



Wir sind für Sie da!

Schnelle Hilfe 24/7
www.held-hilft.de

Ersatzteil-Sofort-Hilfe:
0571-7983810

29-08-2018

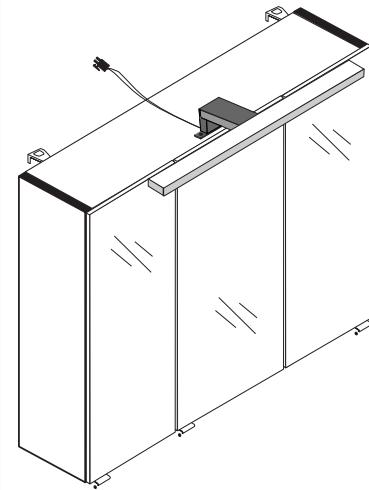

3D-Effekt

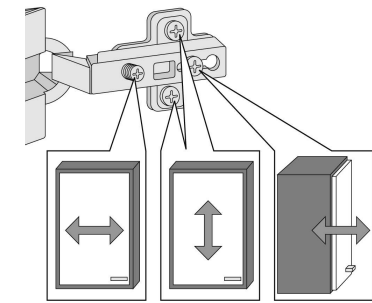
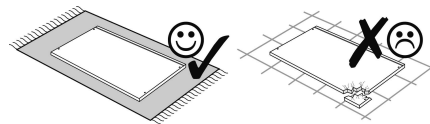
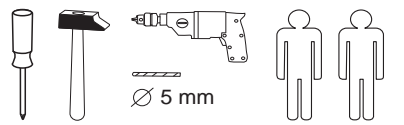
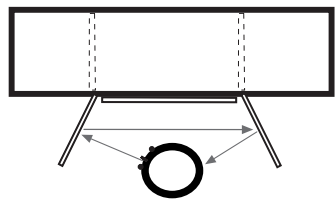

1 4 x 2802	2 4 x 2801	gedämpft 3 3 x 1506	ungedämpft 4 3 x 1507	5 6 x 1614
6 24 x 2819	7 25 x 2862	8 3 x 1098	3,0 x 15 9 6 x 2803	10 4 x 30 4 x 2812
11 5,8 x 55 2 x 2840	12 8 x 30 2 x 2842	13 2 x 2843	14 6 x 2865	15 8 x 30 16 x 2861
17 3,5 x 15 12 x 2804	18 1 x 2795	4,0 x 60 2 x 2795	19 1 x 2 x 3,0 x 15	16 1 x 2863

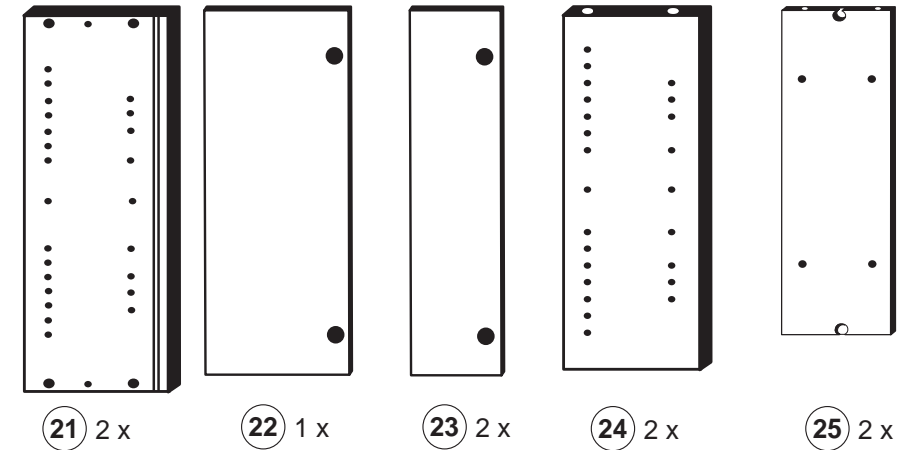
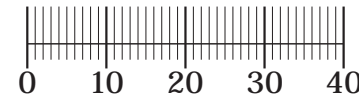

21 2 x 22 1 x 23 2 x 24 2 x 25 2 x



26 4 x



27 2 x

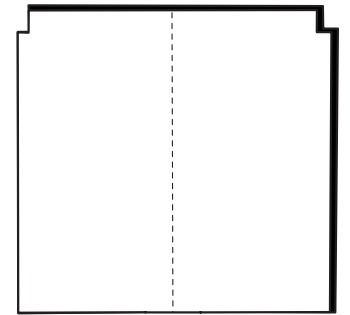

28 1 x

Das beigegefügte Wandbefestigungsmaterial (Dübel und Schrauben) eignet sich nur für festes Mauerwerk (z.B.: Beton- oder Ziegelwände). Für andere Wandaufbauten sind eventuell Spezialdübel und andere Schrauben notwendig. Ziehen Sie gegebenenfalls eine Fachkraft zu Rate.

De begeleidende wandmontage hardware (pluggen en schroeven) is alleen geschikt voor massief metselwerk (bijvoorbeeld beton of bakstenen muren). Voor andere muur structuren zijn eventueel bijzondere ankerbouten en andere noodzakelijke. Draai indien nodig, een deskundige.

Приложенный материал для крепления к стене (дюбели и винты) пригоден только для жестких кладок (например, бетонные или кирпичные стены). Для других настенных конструкций необходимы смотря по обстоятельствам специальные дюбели и другие винты. При необходимости проконсультируйтесь у специалиста.

Le mur d'accompagnement matériel de montage (chevilles et les vis) ne convient que pour la maçonnerie solide (par exemple en béton ou des murs de briques). Pour les structures de mur d'autres sont peut-être spéciale boulons d'ancrage et d'autres nécessaires. Serrer le cas échéant, un expert.

Załączony materiał do mocowania do ściany (kolki rozprężne i wkręty) nadaje się tylko do ścian murowanych (np. z betonu lub cegiel). Do ścian wykonanych w innych technologiach konieczne być mogą specjalne kolki rozprężne i inne wkręty. W razie potrzeby skorzystaj z fachowej pomocy.

Il muro di accompagnamento hardware di montaggio (tasselli e viti) è adatto solo per muratura piena (ad esempio calcestruzzo o muratura). Per le altre strutture murarie sono forse speciali bulloni di ancoraggio e necessari di altri. Serrare se necessario, un esperto.

The accompanying wall mounting hardware (anchors and screws) is suitable only for solid masonry (eg concrete or brick walls). For other wall structures are possibly special anchor bolts and other necessary. Tighten if necessary, an expert.

Ekteki duvara sabit montaj malzemeleri (dübel ve vidalar), sadece sağlam duvarlar için (örnek: beton veya tuğla) elverişlidir. Başka duvarlar için özel dübeller ve farklı vidalar gerekebilir. Gerektiğinde bir bilene danışınız.

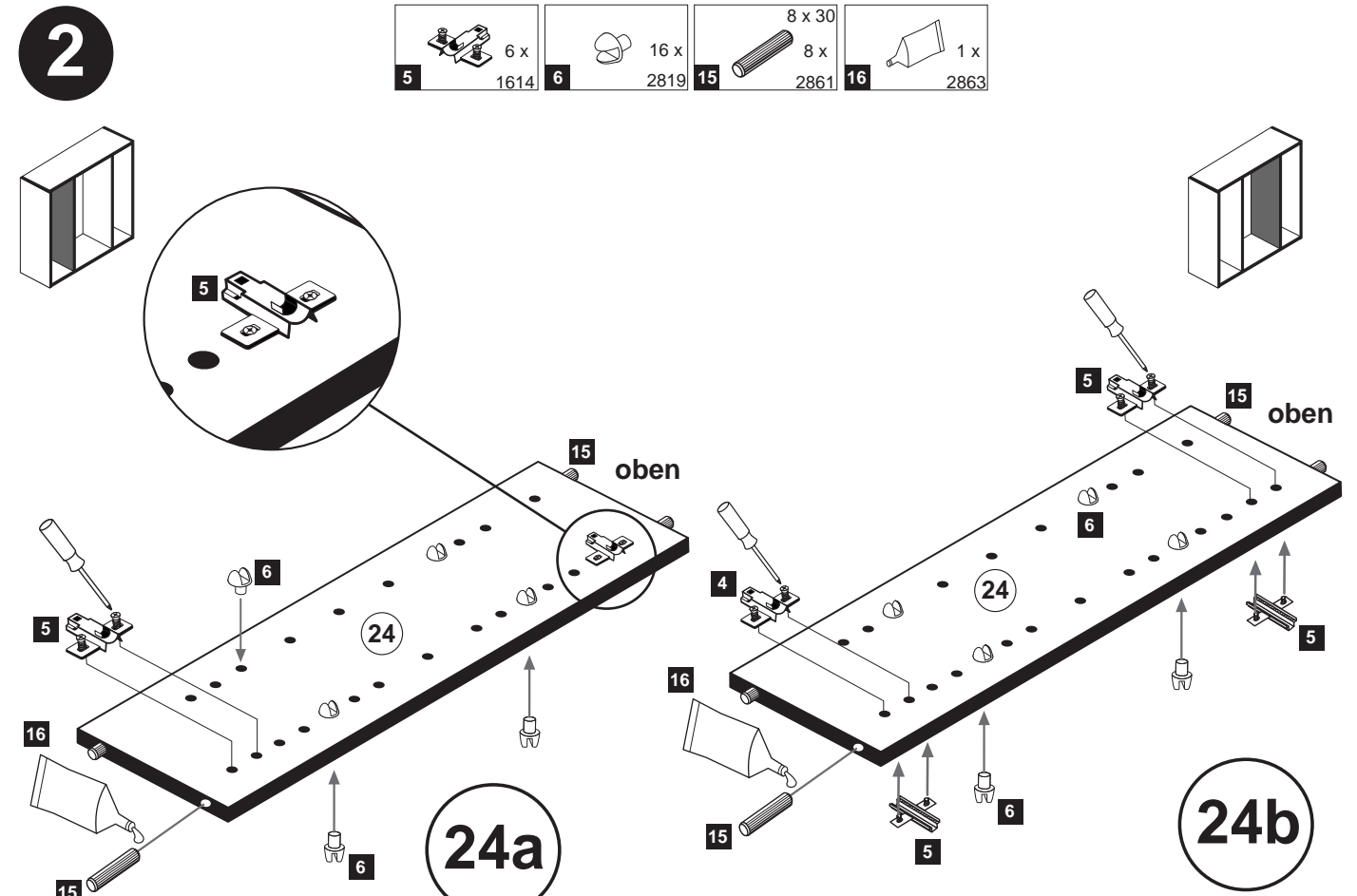
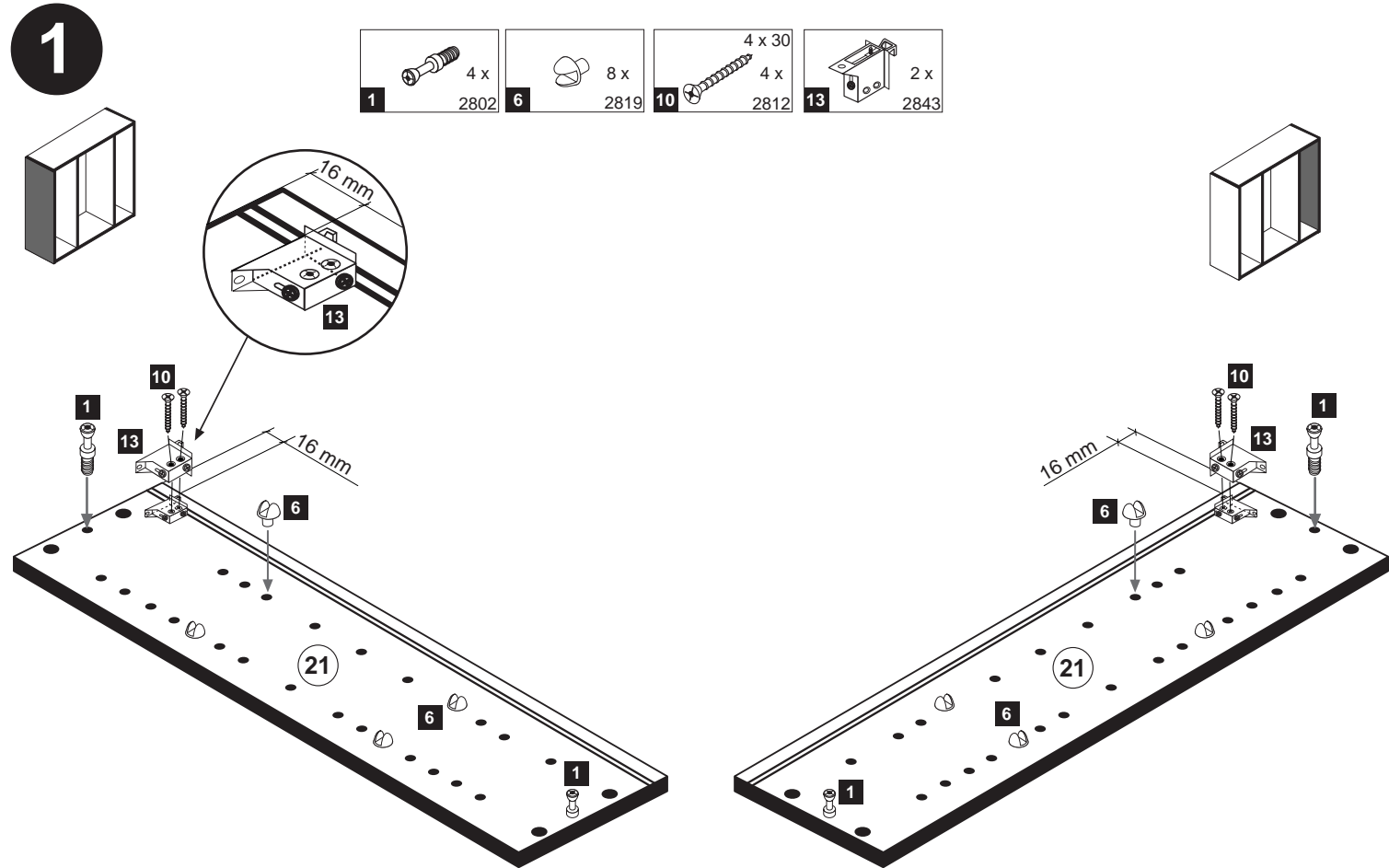

3

2		4 x	15		8 x 30	8 x	16		1 x

4

16		1 x

D Leim
GB Glue
NL Lijm
PL Klej
TR Tutkal
F Colle
I Colla

20 min.

5

Variante 1: Trafomontage unten

Variante 2: Trafomontage oben

Sie können die Position der Trafobox frei wählen. Sägen Sie an der ausgewählten Position eine Aussklung für die Kabel aus.

Die Montage der elektrischen Teile und Verbindungen sind unter Berücksichtigung der VDE 0100 Teil 701 von einer Fachkraft des Elektrohandwerks vorzunehmen.

18		1 x	4,0 x 60		2 x

Bitte nur einen Ausschnitt aussägen. (Montagevariante)

1.

7

6

7		25 x
		2862

2.

8

3		gedämpft	3 x	4		ungedämpft	3 x	14		6 x	17		3,5 x 15	12 x

9

8		3 x	9		3,0 x 15	6 x

10

19		1 x	2 x		3,0 x 15

Montieren Sie die Aufbauleuchte mittig auf dem Schrank!

Scharniermontage

Scharnier lösen

11

11		5,8 x 55	2 x	12		8 x 30	2 x



D



Wichtige Sicherheitshinweise

Die Installation Ihrer neuen Leuchte darf ausschließlich von autorisierten Fachpersonen durchgeführt werden



GB



Important safety instructions

The installation of your new luminaire may only be carried out by authorized specialists.



FR



Consignes de sécurité importantes

La L'installation votre nouveau luminaire doit uniquement être réalisée par des spécialistes autorisés



IT



Importanti disposizioni di sicurezza

L'installazione della il loro nuovo lampada può essere eseguita solo ed esclusivamente da personale tecnico autorizzato.



NL



Belangrijke veiligheidsaanwijzingen

De installatie van de nieuwe lamp moet worden uitgevoerd door vakbekwame personen worden uitgevoerd.



CZ



Důležité bezpečnostní pokyny

Instalaci nových svítidel smí provádět pouze kvalifikovaný elektrikář.



PL



Ważne wskazówki dotyczące bezpieczeństwa

Ta Instalację nowej lampy mogą przeprowadzać wyłącznie autoryzowani instalatorzy



SK



Dôležité bezpečnostné upozornenia

Inštaláciu lampy smú vykonať výhradne autorizovaní



HU



Fontos biztonsági utmutatások

Az On Új lámpájának beszerelését kizárólag hivatalos szakember végezheti el



RO



Instrucțiuni de siguranță importante

Instalarea noii dumneavoastră lămpi este permisă exclusiv specialiștilor autorizați



TR



Önemli güvenlik uyarıları

Yeni lamba montajı yetkin kişiler tarafından yapılmalıdır



RU



важная информация по технике безопасности

Установка вашей новой лампы должна выполняться квалифицированным персоналом



89904.330